

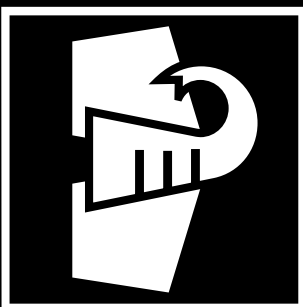

# WEIR®



## **Prefacio**

### **Preface**

#### Prefácio

**Werku proporciona  
herramientas de calidad  
al precio correcto, sin  
renunciar al diseño y la  
innovación tecnológica.  
Con esta simple filosofía,  
cada día más usuarios  
compran Werku.**

Werku provides quality tools  
at the right price, without  
giving up design and  
technological innovation.  
With this simple philosophy,  
every day more users  
buy Werku.

Werku fornece ferramentas de  
qualidade a um preço justo,  
sem comprometer o desenho  
e a inovação tecnológica.  
Com esta filosofia simples,  
todos os dias mais usuários  
compram Werku.



## **Contenido**

## **Contents**

### Contido

**Herramientas eléctricas**

**Herramientas manuales**

**Herramientas neumáticas y airless**

**Escaleras y plataformas**

**Protección y seguridad**

**Químicos técnicos**

Power tools

Hand tools

Pneumatic and airless tools

Ladders and platforms

Protection and safety

Technical chemicals

Ferramentas elétricas

Ferramentas manuais

Ferramentas pneumáticas e airless

Escadas e plataformas

Proteção e segurança

Químicos técnicos



# Herramientas eléctricas

## Power tools

### Ferramentas elétricas



# Lijadora circular paredes-techos

## Circular wall-ceiling sander

Lixadora circular paredes-tetos

**Cuerpo de ABS y acero carbono**

**Interruptor con botón de funcionamiento continuo**

**Sistema de extracción compatible con aspirador**

**Agarre ergonómico antideslizante**

**Mango auxiliar**

**Selector de velocidades**

**Fijación con velcro**

**Extensible**

**Plegable**

**Incluye 6 discos de lijado**

**Incluye manguera de aspiración de 4.5 metros**

ABS and carbon steel body

Switch with continuous operation button

Extraction system compatible with vacuum cleaner

Ergonomic non-slip grip

Auxiliary handle

Speed selector

Velcro fixing

Extendable

Foldable

Includes 6 sanding discs

Includes 4.5-meter suction hose

Corpo de ABS e aço carbono

Interruptor com botão de operação contínua

Sistema de extracção compatible com aspirador

Agarramento ergonómico antiderrapante

Cabo auxiliar

Selector de velocidades

Fixação com velcro









Extensível

Dobrável

Inclui 6 discos de lixado

Inclui mangueira de sucção de 4.5 metros



	<b>WK400030</b> 2 / 001-118.500
	600 W
	600-1500 RPM
	5
	225 MM
	1100-1650 MM
	0-45°
	CE
	8 424835 003487

# Lijadora circular-triangular paredes-techos

## Circular-triangular wall-ceiling sander

Lixadora circular-triangular paredes-tetos

**Cuerpo de ABS y acero carbono**

**Interruptor con botón de funcionamiento continuo**

**Sistema de extracción compatible con aspirador**

**Agarre ergonómico antideslizante**

**Mango auxiliar**

**Selector de velocidades**

**Fijación con velcro**

**Extensible**

**Plegable**

**Incluye 6 discos y 6 hojas triangulares de lijado**

**Incluye manguera de aspiración de 4.5 metros**

ABS and carbon steel body

Switch with continuous operation button

Extraction system compatible with vacuum cleaner

Ergonomic non-slip grip

Auxiliary handle

Speed selector

Velcro fixing

Extendable

Foldable

Includes 6 sanding discs and 6 triangular sanding sheets

Includes 4.5-meter suction hose

Corpo de ABS e aço carbono

Interruptor com botão de operação contínua

Sistema de extracção compatible com aspirador

Agarramento ergonómico antiderrapante

Cabo auxiliar

Selector de velocidades

Fixação com velcro











Extensível

Dobrável

Inclui 6 discos e 6 folhas triangulares de lixado

Inclui manguera de sucção de 4,5 metros



	<b>WK400080</b> 2 / 001-139.500
	600 W
	600-1500 RPM
	5
	225 MM
	285 X 285 X 285 MM
	1100-1650 MM
	0-45°
	CE
	8 424835 006440



# Lijadora circular paredes-techos

## Circular wall-ceiling sander

Lixadora circular paredes-tetos

**Cuerpo de ABS y acero carbono**

**Interruptor de funcionamiento continuo**

**Sistema de extracción compatible con aspirador**

**Agarre ergonómico antideslizante**

**Mango auxiliar orientable**

**Selector de velocidades**

**Fijación con velcro**

**Extensible**

**Incluye 6 discos de lijado**

**Incluye manguera de aspiración de 4.5 metros**

**Incluye bolsa de transporte**

ABS and carbon steel body

Continuous operation switch

Extraction system compatible with vacuum cleaner

Ergonomic non-slip grip

Adjustable auxiliary handle

Speed selector

Velcro fixing

Extendable

Includes 6 sanding discs

Includes 4.5-meter suction hose

Includes transportation bag

Corpo de ABS e aço carbono

Interruptor de operação contínua

Sistema de extracção compatible com aspirador

Agarramento ergonómico antiderrapante

Cabo auxiliar orientável

Selector de velocidades

Fixação com velcro









Extensível

Inclui 6 discos de lixado

Inclui manguera de sucção de 4.5 metros

Inclui bolsa de transporte



	<b>WK403070</b> 2 / 001-152.000
	600 W
	600-1500 RPM
	5
	225 MM
	1100-1900 MM
	0-45°
	CE
	8 424835 001216

# Lijadora circular paredes-techos

## Circular wall-ceiling sander

Lixadora circular paredes-tetos

**Cuerpo de ABS y aluminio**

**Motor sin escobillas**

**Interruptor con botón de funcionamiento continuo**

**Sistema de extracción compatible con aspirador**

**Agarre ergonómico antideslizante**

**Mango auxiliar**

**Selector de velocidades**

**Luz LED integrada**

**Fijación con velcro**

**Extensible**

**Plegable**

**Incluye 6 discos de lijado**

**Incluye manguera de aspiración de 4.5 metros**

**Incluye maletín de transporte**

ABS and aluminium body

Brushless motor

Switch with continuous operation button

Extraction system compatible with vacuum cleaner

Ergonomic non-slip grip

Auxiliary handle

Speed selector

Integrated LED light

Velcro fixing

Extendable

Foldable

Includes 6 sanding discs

Includes 4.5-meter suction hose

Includes transportation case

Corpo de ABS e alumínio

Motor sem escovas

Interruptor com botão de operação contínua

Sistema de extração compatible com aspirador

Agarramento ergonômico antiderrapante

Cabo auxiliar

Selector de velocidades

Luz LED integrada

Fixação com velcro

Extensível









Dobrável

Inclui 6 discos de lixado

Inclui mangueira de sucção de 4.5 metros

Inclui mala de transporte



	<b>WK403260</b> 1 / 001-182.000
	400 W
	900-2100 RPM
	7
	225 MM
	1300-2200 MM
	0-45°
	CE / GS
	8 424835 010294

# Lijadora circular paredes

## Circular wall sander

Lixadora circular paredes

### Cuerpo de ABS

Interruptor con botón de funcionamiento continuo

Sistema de extracción integrado (compatible con aspirador)

Agarre ergonómico antideslizante

Mango con protector de puño

Mango auxiliar de 2 posiciones

Selector de velocidades

Fijación con velcro

Incluye 6 discos de lijado

Incluye manguera de aspiración de 4 metros

Incluye bolsa reutilizable colectora de polvo

Incluye correa de uso

ABS body

Switch with continuous operation button

Integrated extraction system (compatible with vacuum cleaner)

Ergonomic non-slip grip

Fist protector handle

2-position auxiliary handle

Speed selector

Velcro fixing

Includes 6 sanding discs

Includes 4-meter suction hose

Includes reusable dust collection bag

Includes use belt

Corpo de ABS

Interruptor com botão de operação contínua

Sistema de extracção integrado (compatible com

Agarramento ergonómico antiderrapante

Cabo com protector de punho

Cabo auxiliar de 2 posições

Selector de velocidades

Fixação com velcro







Inclui 6 discos de lixado

Inclui mangueira de sucção de 4 metros

Inclui bolsa reutilizável colectora de pó

Inclui correia de uso



	<b>WK403250</b> 2 / 001-079.900
	1220 W
	1500-2300 RPM
	5
	225 MM
	CE
	8 424835 003531

# Lijadora-pulidora circular paredes mortero-yeso

## Circular mortar-drywall sander-polisher

Lixadora-polidora circular paredes argamassa-gesso

**Cuerpo de ABS y aluminio**

**Interruptor con botón de funcionamiento continuo**

**Agarre ergonómico antideslizante**

**Mango auxiliar**

**Incluye disco esponja**

**Incluye disco rascado**

**Incluye disco talocha**

**Incluye disco de lijado**

ABS and aluminium body

Switch with continuous operation button

Ergonomic non-slip grip

Auxiliary handle

Includes sponge disc

Includes scraper disc

Includes trowel disc

Includes sanding disc

Corpo de ABS e alumínio

Interruptor com botão de operação contínua

Agarramento ergonômico antiderrapante

Cabo auxiliar







Inclui disco esponja

Inclui disco rascador

Inclui disco talocha

Inclui disco de lixado



	<b>WK401090</b> 1 / 001-122.000
	710 W
	110 RPM
	390 MM
	M-6
	CE
	8 424835 008215

# Lijadora circular paredes-techos hormigón

## Circular concrete wall-ceiling sander

Lixadora circular paredes-tetos concreto

**Cuerpo de ABS y aluminio**

**Sistema de extracción compatible con aspirador**

**Interruptor de funcionamiento continuo**

**Agarre ergonómico antideslizante**

**Mango auxiliar orientable**

**Selector de velocidades**

**Extensible**

**Incluye disco de diamante**

**Incluye manguera de aspiración de 3.8 metros**

ABS and aluminium body

Extraction system compatible with vacuum cleaner

Continuous operation switch

Ergonomic non-slip grip

Adjustable auxiliary handle

Speed selector

Extendable

Includes diamond disc

Includes 3.8-meter suction hose

Corpo de ABS e alumínio

Sistema de extracção compatible com aspirador

Interruptor de operação contínua

Agarramento ergonômico antiderrapante

Cabo auxiliar orientável

Selector de velocidades

Extensível

Inclui disco de diamante

Inclui mangueira de sucção de 3.8 metros



	<b>WK400210</b> 2 / 001-156.000
	1000 W
	1700-3500 RPM
	7
	125 X 22 MM
	M-14
	1100-1700 MM
	0-45°
	CE
	8 424835 007294

# Lijadora circular paredes hormigón

## Circular concrete wall sander

Lixadora circular paredes concreto

**Cuerpo de ABS y acero carbono**

**Sistema de extracción compatible con aspirador**

**Agarre ergonómico antideslizante**

**Mango auxiliar**

**Selector de velocidades**

**Incluye disco de diamante**

ABS and carbon steel body

Extraction system compatible with vacuum cleaner

Ergonomic non-slip grip

Auxiliary handle

Speed selector

Includes diamond disc

Corpo de ABS e aço carbono

Sistema de extracção compatible com aspirador









Agarramento ergonómico antiderrapante

Cabo auxiliar

Selector de velocidades

Inclui disco de diamante



	<b>WK400200</b> 2 / 001-119.000
	1500 W
	2500-4500 RPM
	7
	125 X 22 MM
	M-14
	CE
	8 424835 007287

## Sierra circular mármol-piedra

Marble-stone circular saw

Serra circular mármore-pedra

**Cuerpo de ABS y aluminio**

**Interruptor con botón de funcionamiento continuo**

**Agarre ergonómico antideslizante**

**Mango con protector de puño**

**Sistema de refrigeración con agua**

**Base graduable**

**Incluye disco de corte**

**Incluye manguera de suministro de agua**

ABS and aluminium body

Switch with continuous operation button

Ergonomic non-slip grip

Fist protector handle

Water cooling system

Adjustable base

Includes cutting disc

Includes water supply hose

Corpo de ABS e alumínio

Interruptor com botão de operação contínua

Agarramento ergonômico antiderrapante

Cabo com protector de punho









Sistema de refrigeração com água

Base graduável

Inclui disco de corte

Inclui mangueira de abastecimento de água



	<b>WK400740</b> 4 / 001-044.000
	1250 W
	13800 RPM
	110/125 X 20 MM
	0 - 30/40 MM
	M-6
	45°
	CE
	8 424835 009526

## Cepillo paredes hormigón

Concrete wall planer

Plaina paredes concreto

**Cuerpo de ABS y aluminio**

**Sistema de extracción compatible con aspirador**

**Agarre ergonómico antideslizante**

**Mango con protector de puño**

**Mango auxiliar**

**Incluye disco de diamante**

**Incluye manguera de aspiración de 1.5 metros**

**Incluye maletín de transporte**

ABS and aluminium body

Extraction system compatible with vacuum cleaner

Ergonomic non-slip grip

Fist protector handle

Auxiliary handle

Includes diamond disc

Includes 1.5-meter suction hose

Includes transportation case

Corpo de ABS e alumínio

Sistema de extracção compatible com aspirador

Agarramento ergonômico antiderrapante

Cabo com protector de punho







Cabo auxiliar

Inclui disco de diamante

Inclui mangueira de sucção de 1.5 metros

Inclui mala de transporte



	<b>WK401100</b> 1 / 001-152.000
	1200 W
	9600 RPM
	0-3.5 MM
	52 MM
	CE
	8 424835 008222

# Rozadora paredes

## Wall chaser

### Roçadora paredes

**Cuerpo de ABS y aluminio**

**Sistema de extracción integrado (compatible con aspirador)**

**Agarre ergonómico antideslizante**

**Mango auxiliar**

**Sistema de refrigeración con agua**

**Incluye disco de corte de triple hoja**

**Incluye bolsa reutilizable colectora de polvo**

**Incluye manguera de aspiración de 1 metro**

**Incluye maletín de transporte**

ABS and aluminium body

Integrated extraction system (compatible with vacuum cleaner)

Ergonomic non-slip grip

Auxiliary handle

Water cooling system

Includes triple blade cutting disc

Includes reusable dust collection bag

Includes 1-meter suction hose

Includes transportation case

Corpo de ABS e alumínio

Sistema de extracção integrado (compatible com aspirador)

Agarramento ergonómico antiderrapante

Cabo auxiliar

Sistema de refrigeração com água









Inclui disco de corte de tripla folha

Inclui bolsa reutilizável colectora de pó

Inclui mangueira de sucção de 1 metro

Inclui mala de transporte



	<b>WK403230</b> 2 / 001-158.500
	2400 W
	8000 RPM
	150 X 22 MM
	M-8
	8-43 MM
	28 MM
	CE
	8 424835 009052



# Aspirador seco-húmedo

## Dry-wet vacuum cleaner

### Aspirador seco-úmido

**Cuerpo de ABS**

**Tanque de aluminio**

**Ruedas de polipropileno de 50 mm**

**Ruedas orientables en 360 grados**

**Interruptor de funcionamiento continuo**

**Doble filtrado mediante bolsa de polvo y filtro HEPA**

**Función de sincronización con herramientas eléctricas**

**Función de soplado de aire**

**Cadena anti-electrostática**

**Incluye accesorios de limpieza**

**Incluye manguera de aspiración de 1.5 metros**

**Incluye bolsa reutilizable colectora de polvo**

**Incluye filtro HEPA para sólidos**

**Incluye filtro esponja para líquidos**

ABS body

Aluminium tank

Polypropylene wheels of 50 mm

Adjustable wheels in 360 degrees

Continuous operation switch

Double filtering by dust bag and HEPA filter

Power tool synchronization function

Air blow function

Anti-electrostatic chain

Includes cleaning accessories

Includes 1.5-meter suction hose

Includes reusable dust collection bag

Includes HEPA filter for solids

Includes sponge filter for liquids

Corpo de ABS

Tanque de alumínio

Rodas de polipropileno de 50 mm

Rodas ajustáveis em 360 graus

Interruptor de operação contínua

Duplo filtragem através de saco de pó e filtro HEPA

Função de sincronização com ferramentas elétricas

Função soprado de ar

Cadeia anti-eletrostática

Inclui acessórios de limpeza









Inclui mangueira de sucção de 1.5 metros

Inclui bolsa reutilizável colectora de pó

Inclui filtro HEPA para sólidos

Inclui filtro esponja para líquidos



	<b>WK402010</b> 1 / 001-078.500	<b>WK402020</b> 1 / 001-085.500
	1200 W	1200 W
	20 L	30 L
	3500 LPM	3500 LPM
	180 MBAR	180 MBAR
	≤ 2000 W	≤ 2000 W
	CE	CE
	8 424835 007218	8 424835 007225

## Aspirador seco-húmedo

### Dry-wet vacuum cleaner

Aspirador seco-úmido

**Cuerpo de ABS**

**Tanque de aluminio**

**Ruedas de PVC de 63 y 150 mm**

**Ruedas orientables en 360 grados**

**Asa de transporte**

**Interruptor de funcionamiento continuo**

**Doble filtrado mediante bolsa de polvo y filtro HEPA**

**Función de sincronización con herramientas eléctricas**

**Función de soplado de aire**

**Cadena anti-electrostática**

**Incluye accesorios de limpieza**

**Incluye manguera de aspiración de 1.5 metros**

**Incluye bolsa reutilizable colectora de polvo**

**Incluye filtro HEPA para sólidos**

**Incluye filtro esponja para líquidos**

ABS body

Aluminium tank

PVC wheels of 63 and 150 mm

Adjustable wheels in 360 degrees

Carrying handle

Continuous operation switch

Double filtering by dust bag and HEPA filter

Power tool synchronization function

Air blow function

Anti-electrostatic chain

Includes cleaning accessories

Includes 1.5-meter suction hose

Includes reusable dust collection bag

Includes HEPA filter for solids

Includes sponge filter for liquids

Corpo de ABS

Tanque de alumínio

Rodas de PVC de 63 e 150 mm

Rodas ajustáveis em 360 graus

Alça de transporte

Interruptor de operação contínua

Duplo filtragem através de saco de pó e filtro HEPA

Função de sincronização com ferramentas elétricas

Função soprado de ar

Cadeia anti-eletrostática

Inclui acessórios de limpeza









Inclui mangueira de sucção de 1.5 metros

Inclui bolsa reutilizável colectora de pó

Inclui filtro HEPA para sólidos

Inclui filtro esponja para líquidos



	<b>WK402030</b> 1 / 001-132.500	<b>WK403310</b> 1 / 001-152.500
	1400 W	1400 W
	50 L	60 L
	3500 LPM	3500 LPM
	180 MBAR	180 MBAR
	≤ 2000 W	≤ 2000 W
	CE	CE
	8 424835 007232	8 424835 010607

# Aspirador seco-húmedo

## Dry-wet vacuum cleaner

Aspirador seco-úmido

**Cuerpo de ABS**

**Tanque de polipropileno/PVC**

**Ruedas de caucho de 50 mm y de polipropileno/PVC de 150 mm**

**Ruedas delanteras orientables en 360 grados**

**Asa de transporte acolchada de caucho**

**Interruptor de funcionamiento continuo**

**Triple filtrado mediante bolsa de polvo, depósito de agua y filtro HEPA**

**Regulador de potencia**

**Función de sincronización con herramientas eléctricas**

**Función de soplado de aire**

**Función de limpieza rápida del filtro**

**Incluye accesorios de limpieza**

**Incluye manguera de aspiración de 2 metros**

**Incluye 2 bolsas reutilizables colectoras de polvo**

**Incluye filtro HEPA para sólidos**

**Incluye filtro esponja para líquidos**

ABS body

Polypropylene/PVC tank

Rubber wheels of 50 mm and polypropylene/PVC wheels of 150 mm

Adjustable front wheels in 360 degrees

Rubber padded carrying handle

Continuous operation switch

Triple filtering by dust bag, water tank and HEPA filter

Power regulator

Power tool synchronization function

Air blow function

Filter quick clean function

Includes cleaning accessories

Includes 2-meter suction hose

Includes 2 reusable dust collection bags

Includes HEPA filter for solids

Includes sponge filter for liquids

Corpo de ABS

Tanque de polipropileno/PVC

Rodas de borracha de 50 mm e de polipropileno/PVC de 150 mm

Rodas dianteiras ajustáveis em 360 graus

Alça de transporte acolchoada de borracha

Interruptor de operação contínua

Tripla filtração através de saco de pó, tanque de água e filtro HEPA

Regulador de potência

Função de sincronização com ferramentas elétricas

Função soprado de ar

Função de limpeza rápida do filtro

Inclui acessórios de limpeza









Inclui mangueira de sucção de 2 metros

Inclui 2 bolsas reutilizáveis colectoras de pó

Inclui filtro HEPA para sólidos

Inclui filtro esponja para líquidos



	<b>WK401450</b> 1 / 001-199.000
	1600 W
	30 L
	3700 LPM
	180 MBAR
	≤ 2000 W
	CE
	8 424835 010065

**Bolsa polvo aspirador**  
**Vacuum cleaner dustbag**  
 Saco pó aspirador

**Cuerpo de polipropileno SMS**  
**Reutilizable**  
**Lavable**

SMS polypropylene body  
 Reusable  
 Washable

Corpo de polipropileno SMS  
 Reutilizável  
 Lavável



**WK402010**  
**WK402020**  
**WK402030**  
**WK403310**  
**WK401450**



	<b>WK300530</b> 5 / 001-006.200	<b>WK300540</b> 5 / 001-008.200
	20-30 L	50-60 L
	450 MM	580 MM
	280 MM	330 MM
	36-61 MM	36-61 MM
PCS	2	2
	CE	CE
	8 424835 010614	8 424835 010621

# Mezclador

## Mixer

### Misturador

**Cuerpo de ABS y aluminio**

**Interruptor con botón de funcionamiento continuo**

**Agarre ergonómico antideslizante**

**Mango auxiliar de 3 posiciones**

**Regulador de velocidad**

**Función de rotación reversible**

**Incluye varilla mezcladora**

ABS and aluminium body

Switch with continuous operation button

Ergonomic non-slip grip

3-position auxiliary handle

Speed regulator

Reversible rotation function

Includes mixer stirrer

Corpo de ABS e alumínio

Interruptor com botão de operação contínua

Agarramento ergonômico antiderrapante











Cabo auxiliar de 3 posições

Regulador de velocidade

Função de rotação reversível

Inclui varilha misturadora



	<b>WK403140</b> 4 / 001-052.000
	1050 W
	0-580 RPM
	45 NM
	M-14
	120 MM
	600 MM
	50 KG
	CE
	8 424835 505059

## Mezclador

### Mixer

Misturador

**Cuerpo de ABS y aluminio**

**Interruptor con botón de funcionamiento continuo**

**Agarre ergonómico antideslizante**

**Selector de velocidades**

**Selector de 2 rangos de revoluciones**

**Incluye varilla mezcladora**

ABS and aluminium body

Switch with continuous operation button

Ergonomic non-slip grip

Speed selector

2-speed range selector

Includes mixer stirrer

Corpo de ABS e alumínio

Interruptor com botão de operação contínua

Agarramento ergonômico antiderrapante

Selector de velocidades

Selector de 2 níveis de rotações

Inclui varilla misturadora



## Mezclador doble

### Double mixer

Misturador duplo

**Cuerpo de ABS y aluminio**

**Interruptor con botón de funcionamiento continuo**

**Agarre ergonómico antideslizante**

**Selector de velocidades**

**Selector de 2 rangos de revoluciones**

**Incluye 2 varillas mezcladoras**

ABS and aluminium body

Switch with continuous operation button

Ergonomic non-slip grip

Speed selector

2-speed range selector

Includes 2 mixer stirrers

Corpo de ABS e alumínio

Interruptor com botão de operação contínua











Agarramento ergonômico antiderrapante











Selector de velocidades

Selector de 2 níveis de rotações

Inclui 2 varilhas misturadoras



	<b>WK400130</b> 2 / 001-068.800
	1600 W
	180-460/300-750 RPM
	12
	60 NM
	M-14
	140 MM
	600 MM
	75 KG
	CE
	8 424835 001339

	<b>WK403240</b> 2 / 001-098.800
	1600 W
	200-480/250-680 RPM
	12
	70 NM
	HEX-13
	120 MM
	550 MM
	100 KG
	CE
	8 424835 007980

## Varilla mezclador

### Mixer stirrer

#### Varinha misturador

**Cuerpo de acero galvanizado**

**Juntas reforzadas con soldadura TIG**

**Conexión hexagonal para taladros**

**Compatible con mezclas de viscosidad baja**

**Dirección de fluido hacia abajo**

Galvanized steel body

Reinforced TIG welding joints

Hexagonal connection for drills

Compatible with low viscosity mixtures

Downwards fluid direction

Corpo de aço galvanizado







Juntas reforçadas com soldadura TIG

Conexão hexagonal para berbequims

Compatível com misturas de viscosidade baixa

Direção do fluido para baixo



	<b>WK602210</b> 12 / 006-001.800	<b>WK602220</b> 12 / 006-002.000	<b>WK602230</b> 12 / 006-003.800	<b>WK602240</b> 12 / 006-004.000
	HEX-8	HEX-8	HEX-9	HEX-9
	60 MM	80 MM	100 MM	120 MM
	400 MM	400 MM	600 MM	600 MM
	5-10 KG	5-15 KG	10-25 KG	15-30 KG
	8 424835 001421	8 424835 001155	8 424835 002497	8 424835 001162

## Varilla mezclador

### Mixer stirrer

#### Varinha misturador

**Cuerpo de acero galvanizado**

**Juntas reforzadas con soldadura TIG**

**Conexión hexagonal para taladros**

**Compatible con mezclas de viscosidad media**

**Dirección de fluido hacia arriba**

Galvanized steel body

Reinforced TIG welding joints

Hexagonal connection for drills

Compatible with medium viscosity mixtures

Upwards fluid direction

Corpo de aço galvanizado







Juntas reforçadas com soldadura TIG

Conexão hexagonal para berbequims

Compatível com misturas de viscosidade média

Direção do fluido para cima



	<b>WK602100</b> 6 / 001-003.800	<b>WK602110</b> 6 / 001-004.200
	HEX-8	HEX-8
	100 MM	120 MM
	600 MM	600 MM
	10-25 KG	15-30 KG
	8 424835 510022	8 424835 002855

## Varilla mezclador

### Mixer stirrer

#### Varinha misturador

**Cuerpo de acero galvanizado**

**Juntas reforzadas con soldadura TIG**

**Conexión hexagonal para taladros**

**Compatible con mezclas de viscosidad alta**

**Dirección de fluido hacia arriba**

Galvanized steel body

Reinforced TIG welding joints

Hexagonal connection for drills

Compatible with high viscosity mixtures

Upwards fluid direction

Corpo de aço galvanizado







Juntas reforçadas com soldadura TIG

Conexão hexagonal para berbequims

Compatível com misturas de viscosidade alta

Direção do fluido para cima



	<b>WK602080</b> 6 / 001-005.400	<b>WK602090</b> 6 / 001-005.800
	HEX-9	HEX-9
	100 MM	120 MM
	600 MM	600 MM
	10-25 KG	15-30 KG
	8 424835 006631	8 424835 006648

## Varilla mezclador

### Mixer stirrer

Varinha misturador

**Cuerpo de acero galvanizado**

**Juntas reforzadas con soldadura TIG**

**Conexión métrica para mezcladores**

**Compatible con mezclas de viscosidad media**

**Dirección de fluido hacia arriba**

Galvanized steel body

Reinforced TIG welding joints

Metric connection for mixers

Compatible with medium viscosity mixtures

Upwards fluid direction

Corpo de aço galvanizado







Juntas reforçadas com soldadura TIG

Conexão métrica para misturadores

Compatível com misturas de viscosidade média

Direção do fluido para cima



	<b>WK602010</b> 6 / 001-006.600	<b>WK602020</b> 6 / 001-007.200
	M-14	M-14
	120 MM	140 MM
	600 MM	600 MM
	15-30 KG	15-60 KG
	8 424835 001018	8 424835 003869

## Varilla mezclador

### Mixer stirrer

Varinha misturador

**Cuerpo de acero galvanizado**

**Juntas reforzadas con soldadura TIG**

**Conexión métrica para mezcladores**

**Compatible con mezclas de viscosidad alta**

**Dirección de fluido hacia arriba**

Galvanized steel body

Reinforced TIG welding joints

Metric connection for mixers

Compatible with high viscosity mixtures

Upwards fluid direction

Corpo de aço galvanizado





Juntas reforçadas com soldadura TIG

Conexão métrica para misturadores

Compatível com misturas de viscosidade alta

Direção do fluido para cima



	<b>WK602030</b> 6 / 001-007.200	<b>WK602040</b> 6 / 001-007.800
	M-14	M-14
	120 MM	140 MM
	600 MM	600 MM
	15-30 KG	15-60 KG
	8 424835 006655	8 424835 006662



## Pistola pintar succión HVLP-I

### HVLP-I suction paint spray gun

Pistola pintar sucção HVLP-I

Cuerpo de ABS

Agarre ergonómico antideslizante

Cabezal de liberación rápida

Cabezal intercambiable

Control de abanico

Regulador de fluido

Incluye viscosímetro

ABS body

Ergonomic non-slip grip

Quick release head

Interchangeable head

Pattern control

Fluid spray regulator

Includes viscometer

Corpo de ABS

Agarramento ergonômico antiderrapante

Cabeçal de liberação rápida

Cabeçal intercambiável

Controle de leque

Regulador de fluido









Inclui viscosímetro



**HVLP-I (alto volumen a baja presión) reduce el consumo del producto a pulverizar un 30%, acorta el tiempo de trabajo un 20%, disminuye el consumo de aire un 15% y genera una buena calidad de pulverización y acabado.**

HVLP-I (high volume at low pressure) reduces the consumption of the product to be sprayed by 30%, shortens the working time by 20%, reduces air consumption by 15% and generates a good quality of spray and finish.

HVLP-I (alto volumen a baixa pressão) reduz o consumo do produto a ser pulverizado em 30%, reduz o tempo de trabalho em 20%, reduz o consumo de ar em 15% e gera uma boa qualidade de pulverização e acabamento.

	<b>WK401200</b> 6 / 001-039.500
	500 W
	140 BAR
	1.8 / 2.6 MM
	80 DIN SEC
	800 ML
	800 ML MIN
	CE
	8 424835 007669

## Pistola pintar succión turbina HVLP-I

### HVLP-I turbine suction paint spray gun

Pistola pintar sucção turbina HVLP-I

Cuerpo de ABS

Agarre ergonómico antideslizante

Cabezal de liberación rápida

Cabezal intercambiable

Control de abanico

Regulador de fluido

Incluye viscosímetro

Incluye correa de uso

Incluye manguera de 1.8 metros

ABS body

Ergonomic non-slip grip

Quick release head

Interchangeable head

Pattern control

Fluid spray regulator

Includes viscometer

Includes use belt

Includes 1.8-meter hose

Corpo de ABS

Agarramento ergonômico antiderrapante

Cabeçal de liberação rápida

Cabeçal intercambiável

Controle de leque

Regulador de fluido

Inclui viscosímetro









Inclui corria de uso



**HVLP-I (alto volumen a baja presión) reduce el consumo del producto a pulverizar un 30%, acorta el tiempo de trabajo un 20%, disminuye el consumo de aire un 15% y genera una buena calidad de pulverización y acabado.**

HVLP-I (high volume at low pressure) reduces the consumption of the product to be sprayed by 30%, shortens the working time by 20%, reduces air consumption by 15% and generates a good quality of spray and finish.

HVLP-I (alto volumen a baixa pressão) reduz o consumo do produto a ser pulverizado em 30%, reduz o tempo de trabalho em 20%, reduz o consumo de ar em 15% e gera uma boa qualidade de pulverização e acabamento.

	<b>WK401210</b> 2 / 001-055.000
	650 W
	140 BAR
	1.8 / 2.6 MM
	80 DIN SEC
	800 ML
	800 ML MIN
	CE
	8 424835 007676

# Pistola pintar succión turbina-trolley HVLP-I

## HVLP-I turbine-trolley suction paint spray gun

### Pistola pintar sucção turbina-trolley HVLP-I

**Cuerpo de ABS**

**Ruedas de ABS de 130 mm**

**Agarre ergonómico antideslizante**

**Asa extensible**

**Cabezal de liberación rápida**

**Cabezal intercambiable**

**Control de abanico**

**Regulador de fluido**

**Incluye viscosímetro**

**Incluye manguera de 3 metros**

ABS body

ABS wheels of 130 mm

Ergonomic non-slip grip

Extendable handle

Quick release head

Interchangeable head

Pattern control

Fluid spray regulator

Includes viscometer

Includes 3-meter hose

Corpo de ABS

Rodas de ABS de 130 mm

Agarramento ergonômico antiderrapante

Alça extensível

Cabeçal de liberação rápida

Cabeçal intercambiável

Controle de leque

Regulador de fluido

Inclui viscosímetro









Inclui mangueira de 3 metros



**HVLP-I (alto volumen a baja presión) reduce el consumo del producto a pulverizar un 30%, acorta el tiempo de trabajo un 20%, disminuye el consumo de aire un 15% y genera una buena calidad de pulverización y acabado.**

HVLP-I (high volume at low pressure) reduces the consumption of the product to be sprayed by 30%, shortens the working time by 20%, reduces air consumption by 15% and generates a good quality of spray and finish.

HVLP-I (alto volumen a baixa pressão) reduz o consumo do produto a ser pulverizado em 30%, reduz o tempo de trabalho em 20%, reduz o consumo de ar em 15% e gera uma boa qualidade de pulverização e acabamento.

	<b>WK401180</b> 2 / 001-066.000
	750 W
	140 BAR
	1.8 / 2.6 MM
	80 DIN SEC
	800 ML
	800 ML MIN
	CE
	8 424835 007652

## Pistola aire caliente

### Hot air gun

Pistola ar quente

**Cuerpo de ABS**

**Interruptor de funcionamiento continuo**

**Agarre ergonómico antideslizante**

**Mango con protector de puño**

**Selector de velocidades**

**Incluye 6 accesorios de rascado**

**Incluye maletín de transporte**

ABS body

Continuous operation switch

Ergonomic non-slip grip

Fist protector handle

Speed selector

Includes 6 scraper accessories

Includes transportation case

Corpo de ABS

Interruptor de operação contínua

Agarramento ergonômico antiderrapante

Cabo com protector de punho

Selector de velocidades

Inclui 6 acessórios de raspagem

Inclui mala de transporte



## Pistola aire caliente

### Hot air gun

Pistola ar quente

**Cuerpo de ABS**

**Interruptor de funcionamiento continuo**

**Agarre ergonómico antideslizante**

**Mango con protector de puño**

**Control gradual de la temperatura**

**Selector de velocidades**

**Incluye 6 accesorios de rascado**

**Incluye maletín de transporte**

ABS body

Continuous operation switch

Ergonomic non-slip grip

Fist protector handle

Gradual temperature control

Speed selector

Includes 6 scraper accessories

Includes transportation case

Corpo de ABS

Interruptor de operação contínua

Agarramento ergonômico antiderrapante

Cabo com protector de punho

Controle gradual da temperatura

Selector de velocidades

Inclui 6 acessórios de raspagem

Inclui mala de transporte



	<b>WK402060</b> 10 / 001-019.500
	2000 W
	300-500 LPM
	2
	350-600° C
	CE
	8 424835 007461

	<b>WK402070</b> 10 / 001-026.500
	2000 W
	300-500 LPM
	3
	50-600° C
	CE
	8 424835 007645

# Pistola aire caliente digital

## Digital hot air gun

Pistola ar quente digital

**Cuerpo de ABS**

**Interruptor de funcionamiento continuo**

**Agarre ergonómico antideslizante**

**Mango con protector de puño**

**Control gradual de la temperatura**

**Selector de velocidades**

**Display digital**

**Incluye 6 accesorios de rascado**

**Incluye maletín de transporte**

ABS body

Continuous operation switch

Ergonomic non-slip grip

Fist protector handle

Gradual temperature control

Speed selector

Digital display

Includes 6 scraper accessories

Includes transportation case

Corpo de ABS

Interruptor de operação contínua

Agarramento ergonômico antiderrapante

Cabo com protector de punho

Controle gradual da temperatura







Selector de velocidades

Display digital

Inclui 6 acessórios de raspagem

Inclui mala de transporte



	<b>WK402080</b> 10 / 001-035.500
	2000 W
	300-500 LPM
	3
	50-600° C
	CE
	8 424835 007454

## Lijadora triangular

### Triangular sander

#### Lixadora triangular

Cuerpo de ABS

Interruptor de funcionamiento continuo

Sistema de extracción integrado

Agarre ergonómico antideslizante

Fijación con velcro

Incluye hoja de lijado

Incluye colector de polvo

ABS body

Continuous operation switch

Integrated extraction system

Ergonomic non-slip grip

Velcro fixing

Includes sanding sheet

Includes dust collector

Corpo de ABS

Interruptor de operação contínua

Sistema de extracção integrado

Agarramento ergonómico antiderrapante

Fixação com velcro

Inclui folha lixada

Inclui colector de pó



## Lijadora rectangular

### Rectangular sander

#### Lixadora rectangular

Cuerpo de ABS y base de aluminio

Interruptor de funcionamiento continuo

Sistema de extracción integrado

Agarre ergonómico antideslizante

Fijación con clip de ajuste

Incluye hoja de lijado

Incluye colector de polvo

ABS body and aluminium base

Continuous operation switch

Integrated extraction system

Ergonomic non-slip grip

Adjustment clip fixing

Includes sanding sheet

Includes dust collector

Corpo de ABS e base de alumínio

Interruptor de operação contínua

Sistema de extracção integrado







Agarramento ergonómico antiderrapante







Fixação com clipe de ajuste

Inclui folha lixada

Inclui colector de pó



	<b>WK400040</b> 10 / 001-024.800
	200 W
	15000 RPM
	80 X 140 X 140 MM
	2 MM
	CE
	8 424835 003838

	<b>WK400050</b> 10 / 001-026.600
	240 W
	13000 RPM
	110 X 100 MM
	2 MM
	CE
	8 424835 006013

## Lijadora rectangular

### Rectangular sander

Lixadora rectangular

**Cuerpo de ABS y base de aluminio**

**Interruptor de funcionamiento continuo**

**Sistema de extracción integrado**

**Agarre ergonómico antideslizante**

**Mango con protector de puño**

**Selector de velocidades**

**Fijación con clip de ajuste**

**Incluye hoja de lijado**

**Incluye colector de polvo**

ABS body and aluminium base

Continuous operation switch

Integrated extraction system

Ergonomic non-slip grip

Fist protector handle

Speed selector

Adjustment clip fixing

Includes sanding sheet

Includes dust collector

Corpo de ABS e base de alumínio

Interruptor de operação contínua

Sistema de extracção integrado

Agarramento ergonómico antiderrapante

Cabo com protector de punho

Selector de velocidades

Fixação com clipe de ajuste

Inclui folha lixada

Inclui colector de pó



## Lijadora rectangular

### Rectangular sander

Lixadora rectangular

**Cuerpo de ABS y base de aluminio**

**Interruptor de funcionamiento continuo**

**Sistema de extracción integrado**

**Agarre ergonómico antideslizante**

**Mango con protector de puño**

**Selector de velocidades**

**Fijación con clip de ajuste**

**Incluye hoja de lijado**

**Incluye colector de polvo**

ABS body and aluminium base

Continuous operation switch

Integrated extraction system

Ergonomic non-slip grip

Fist protector handle

Speed selector

Adjustment clip fixing

Includes sanding sheet

Includes dust collector

Corpo de ABS e base de alumínio

Interruptor de operação contínua

Sistema de extracção integrado

Agarramento ergonómico antiderrapante

Cabo com protector de punho









Selector de velocidades









Fixação com clipe de ajuste

Inclui folha lixada

Inclui colector de pó



	<b>WK403150</b> 8 / 001-030.500
	240 W
	6000-12000 RPM
	6
	90 X 187 MM
	2 MM
	CE
	8 424835 005818

	<b>WK403270</b> 8 / 001-036.600
	350 W
	6000-11000 RPM
	7
	115 X 230 MM
	2 MM
	CE / GS
	8 424835 010300

## Lijadora circular

### Circular sander

Lixadora circular

**Cuerpo de ABS**

**Interruptor de funcionamiento continuo**

**Sistema de extracción integrado**

**Agarre ergonómico antideslizante**

**Mango con protector de puño**

**Selector de velocidades**

**Fijación con velcro**

**Incluye disco de lijado**

**Incluye colector de polvo**

ABS body

Continuous operation switch

Integrated extraction system

Ergonomic non-slip grip

Fist protector handle

Speed selector

Velcro fixing

Includes sanding disc

Includes dust collector

Corpo de ABS

Interruptor de operação contínua

Sistema de extracção integrado

Agarramento ergonómico antiderrapante

Cabo com protector de punho

Selector de velocidades

Fixação com velcro

Inclui disco de lixado

Inclui colector de pó



## Lijadora circular orbital

### Orbital circular sander

Lixadora circular orbital

**Cuerpo de ABS**

**Interruptor de funcionamiento continuo**

**Sistema de extracción integrado**

**Mango auxiliar orientable**

**Selector de velocidades**

**Función de giro orbital**

**Fijación con velcro**

**Incluye colector de polvo**

ABS body

Continuous operation switch

Integrated extraction system

Adjustable auxiliary handle

Speed selector

Orbital spin function

Velcro fixing

Includes dust collector

Corpo de ABS

Interruptor de operação contínua

Sistema de extracção integrado

Cabo auxiliar orientável









Selector de velocidades









Função de rotação orbital

Fixação com velcro

Inclui colector pó



	<b>WK400060</b> 8 / 001-038.600
	450 W
	6000-12000 RPM
	6
	150 MM
	2 MM
	CE
	8 424835 006020

	<b>WK400100</b> 4 / 001-077.200
	710 W
	3000-6300 RPM
	6
	150 MM
	4 MM
	CE
	8 424835 006549

# Lijadora circular orbital

## Orbital circular sander

Lixadora circular orbital

**Cuerpo de ABS**

**Motor sin escobillas**

**Sistema de extracción compatible con aspirador**

**Mango con protector de puño**

**Regulador de velocidad**

**Función de giro orbital**

**Fijación con velcro**

**Incluye 4 discos de lijado**

**Incluye manguera de aspiración de 1.1 metros**

ABS body

Brushless motor

Extraction system compatible with vacuum cleaner

Fist protector handle

Speed regulator

Orbital spin function

Velcro fixing

Includes 4 sanding discs

Includes 1.1-meter suction hose

Corpo de ABS

Motor sem escovas

Sistema de extracção compatible com aspirador

Cabo com protector de punho

Regulador de velocidade









Função de rotação orbital

Fixação com velcro

Inclui 4 discos de lixado

Inclui manguera de sucção de 1.1 metros



	<b>WK400750</b> 4 / 001-129.000
	350 W
	4000-10000 RPM
	6
	150 MM
	5 MM
	CE
	8 424835 009779



# Pulidora

## Polisher









Polidora

- Cuerpo de ABS y aluminio**
- Mango auxiliar de 2 posiciones**
- Selector de velocidades**
- Fijación con velcro**
- Incluye caperuza de pulido**

- ABS and aluminium body
- 2-position auxiliary handle
- Speed selector
- Velcro fixing
- Includes polish bonnet

- Corpo de ABS e alumínio
- Cabo auxiliar de 2 posições
- Selector de velocidades
- Fixação com velcro
- Inclui carapuça de polido



	<b>WK400110</b> 4 / 001-038.000
	1010 W
	1000-3000 RPM
	7
	180 MM
	2 MM
	M-14
	CE
	8 424835 001834

# Pulidora

## Polisher









Polidora

**Cuerpo de ABS y aluminio**  
**Agarre ergonómico antideslizante**  
**Mango auxiliar orientable**  
**Selector de velocidades**  
**Fijación con velcro**  
**Incluye caperuza de pulido**

ABS and aluminium body  
Ergonomic non-slip grip  
Adjustable auxiliary handle  
Speed selector  
Velcro fixing  
Includes polish bonnet

Corpo de ABS e alumínio  
Agarramento ergonômico antiderrapante  
Cabo auxiliar orientável  
Selector de velocidades  
Fixação com velcro  
Inclui carapuça de polido



	<b>WK402120</b> 4 / 001-056.000
	1400 W
	1000-3000 RPM
	7
	180 MM
	2 MM
	M-14
	CE
	8 424835 008307

## Amoladora

### Grinder

#### Rebarbadora

**Cuerpo de ABS y aluminio**

**Interruptor de funcionamiento continuo**

**Agarre ergonómico**

**Mango auxiliar de 2 posiciones**

**Protector de disco orientable**

ABS and aluminium body

Continuous operation switch

Ergonomic grip

2-position auxiliary handle

Adjustable disc protector

Corpo de ABS e alumínio

Interruptor de operação contínua

Agarramento ergonômico

Cabo auxiliar de 2 posições

Protetor de disco orientável



	<b>WK400900</b> 6 / 001-029.500	<b>WK400910</b> 6 / 001-031.000
	900 W	1100 W
	12000 RPM	12000 RPM
	115/125 X 22 MM	115/125 X 22 MM
	M-14	M-14
	CE	CE
	8 424835 007904	8 424835 007911

## Amoladora

### Grinder

#### Rebarbadora

**Cuerpo de ABS y aluminio**

**Agarre ergonómico antideslizante**

**Mango auxiliar de 2 posiciones**

**Cabezal orientable - Arranque suave**

**Protector de disco orientable**

ABS and aluminium body

Ergonomic non-slip grip

2-position auxiliary handle

Adjustable head - Soft start

Adjustable disc protector

Corpo de ABS e alumínio

Agarramento ergonômico antiderrapante

Cabo auxiliar de 2 posições

Cabeça ajustável - Arranque suave

Protetor de disco orientável



	<b>WK401050</b> 2 / 001-059.500
	2350 W
	6600 RPM
	230 X 22 MM
	M-14
	CE
	8 424835 009946

# Amoladora inalámbrica

## Cordless grinder

Rebarbadora sem fios

**Cuerpo de ABS y aluminio**

**Agarre ergonómico antideslizante**

**Mango auxiliar de 2 posiciones**

**Protector de disco orientable**

**Indicador LED de carga de batería**

**Luz LED integrada**

**Incluye 2 baterías**

**Incluye bolsa de transporte**

ABS and aluminium body

Ergonomic non-slip grip

2-position auxiliary handle

Adjustable disc protector

Battery charge LED indicator

Integrated LED light

Includes 2 batteries

Includes transportation bag

Corpo de ABS e alumínio

Agarramento ergonómico antiderrapante

Cabo auxiliar de 2 posições

Protetor de disco orientável









Indicador LED de carga da bateria

Luz LED integrada

Inclui 2 baterias

Inclui bolsa de transporte



	<b>WK401620</b> 5 / 001-099.500
	20V = 4.0 AH LI-ON
	2.5 H
	8500 RPM
	115/125 X 22 MM
	M-14
	CE
	8 424835 010096

# Sierra calar

## Jig saw

Serra recortes

**Cuerpo de ABS**

**Interruptor con botón de funcionamiento continuo**

**Sistema de extracción compatible con aspirador**

**Agarre ergonómico antideslizante**

**Mango con protector de puño**

**Selector de velocidades**

**Función láser**

**Base graduable**

**Portasierras automático**

**Incluye 2 hojas de sierra**

**Incluye guía de corte**

ABS body

Switch with continuous operation button

Extraction system compatible with vacuum cleaner

Ergonomic non-slip grip

Fist protector handle

Speed selector

Laser function

Adjustable base

Automatic saw chuck

Includes 2 saw blades

Includes cutting guide

Corpo de ABS

Interruptor com botão de operação contínua

Sistema de extracção compatible com aspirador

Agarramento ergonómico antiderrapante

Cabo com protector de punho

Selector de velocidades

Função laser











Base graduável

Portaserras automático

Inclui 2 lâminas de serra

Inclui guia de corte



	<b>WK400950</b> 8 / 001-039.600
	800 W
	0-3000 RPM
	6
	22 MM
	4
	≤ 100 MM
	≤ 10 MM
	0-45°
	CE
	8 424835 007959

## Sierra sable inalámbrica

### Cordless reciprocating saw

Serra sabre sem fios

**Cuerpo de ABS - Agarre ergonómico antideslizante**

**Indicador LED de carga de batería**

**Base extensible - Portasierras automático**

**Incluye 2 baterías y 2 hojas de sierra**

ABS body - Ergonomic non-slip grip

Battery charge LED indicator

Extendable base - Automatic saw chuck

Includes 2 batteries and 2 saw blades

Corpo de ABS - Agarramento ergonómico antiderrapante

Indicador LED de carga da bateria

Base extensível - Portasierras automático

Inclui 2 baterias e 2 lâminas de serra



## Sierra sable

### Reciprocating saw

Serra sabre

**Cuerpo de ABS - Agarre ergonómico antideslizante**

**Interruptor con botón de funcionamiento continuo**

**Mango con protector de puño - Selector de velocidades**

**Base extensible - Portasierras automático**

**Cabezal graduable - Incluye 2 hojas de sierra**

ABS body - Ergonomic non-slip grip

Switch with continuous operation button

Fist protector handle - Speed selector

Extendable base - Automatic saw chuck

Adjustable head - Includes 2 saw blades

Corpo de ABS - Agarramento ergonómico antiderrapante











Interruptor com botão de operação contínua











Cabo com protector de punho - Selector de velocidades

Base extensível - Portasierras automático

Cabeçal ajustável - Inclui 2 lâminas de serra



	<b>WK401030</b> 6 / 001-049.800
	12V = 2.0 AH LI-ON
	1.5 H
	0-2200 RPM
	13 MM
	≤ 50 MM
	≤ 5 MM
	10°
	CE
	8 424835 009731

	<b>WK403160</b> 6 / 001-044.800
	720 W
	0-2500 RPM
	6
	24 MM
	≤ 115 MM
	≤ 10 MM
	180°
	CE
	8 424835 006709

# Disco lija

## Sanding disc

Disco lixa

**Cuerpo de papel, resina y óxido de aluminio**

**Microperforado**

**Grano semiabierto**

**Fijación con velcro**

Paper, resin and aluminium-oxide body

Microperforated

Semi-open grain

Velcro fixing

Corpo de papel, resina e óxido de alumínio

Microperforado

Grano semiabierto

Fixação com velcro



**WK400030**

**WK400080**





**WK403070**



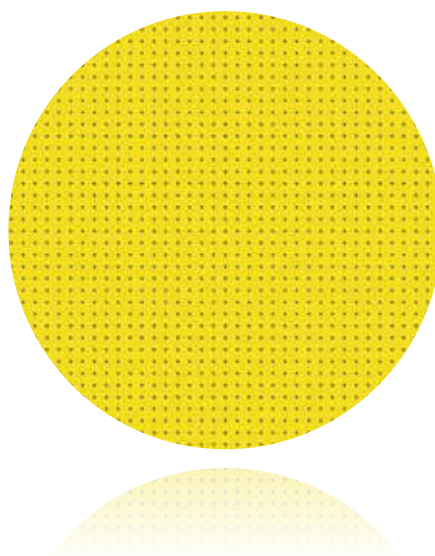

**WK403260**

**WK403250**

**WK601760**



	<b>WK300770</b> 50 / 005-006.500	<b>WK300780</b> 50 / 005-006.500	<b>WK300790</b> 50 / 005-006.500
	225 MM	225 MM	225 MM
	60	80	100
PCS	10	10	10
	8 4248350 010485	8 4248350 010492	8 4248350 010508

	<b>WK300800</b> 50 / 005-006.500	<b>WK300810</b> 50 / 005-006.500	<b>WK300820</b> 50 / 005-006.500	<b>WK300830</b> 50 / 005-006.500
	225 MM	225 MM	225 MM	225 MM
	120	150	180	220
PCS	10	10	10	10
	8 4248350 010515	8 4248350 010522	8 4248350 010539	8 4248350 010546

# Hoja lija

## Sanding sheet

Folha lixa



**Cuerpo de papel, resina y óxido de aluminio**  
**Microperforado**  
**Grano semiabierto**  
**Fijación con velcro**

Paper, resin and aluminium-oxide body  
 Microperforated  
 Semi-open grain  
 Velcro fixing

Corpo de papel, resina e óxido de alumínio  
 Microperforado  
 Grano semiaberto  
 Fixação com velcro

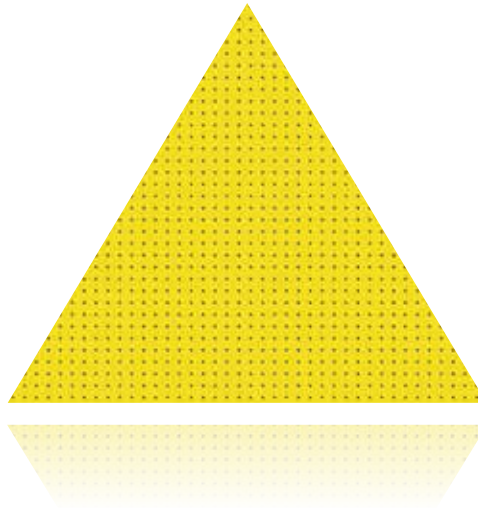

	<b>WK300500</b> 50 / 005-006.500	<b>WK300510</b> 50 / 005-006.500	<b>WK300520</b> 50 / 005-006.500
	285 X 285 X 285 MM	285 X 285 X 285 MM	285 X 285 X 285 MM
	60	80	120
PCS	10	10	10
	8 4248350 010553	8 4248350 010560	8 4248350 010577

# Disco lija

## Sanding disc

Disco lixa



**Cuerpo de papel, resina y óxido de aluminio**  
**Microperforado**  
**Grano semiabierto**  
**Fijación con velcro**

Paper, resin and aluminium-oxide body  
 Microperforated  
 Semi-open grain  
 Velcro fixing

Corpo de papel, resina e óxido de alumínio  
 Microperforado  
 Grano semiaberto  
 Fixação com velcro

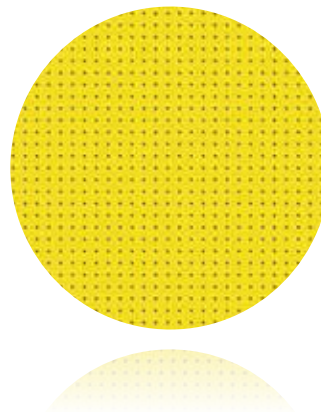

	<b>WK300440</b> 50 / 005-003.200	<b>WK300450</b> 50 / 005-003.200	<b>WK300460</b> 50 / 005-003.200	<b>WK300470</b> 50 / 005-003.200	<b>WK300480</b> 50 / 005-003.200
	150 MM	150 MM	150 MM	150 MM	150 MM
	60	80	100	120	150
PCS	10	10	10	10	10
	8 4248350 010430	8 4248350 010447	8 4248350 010454	8 4248350 010461	8 4248350 010478



**Hoja lija**  
Sanding sheet  
Folha lixa



**Cuerpo de papel, resina y óxido de aluminio**  
**Microperforado**  
**Grano semiabierto**  
**Fijación con velcro**

Paper, resin and aluminium-oxyde body  
Microperforated  
Semi-open grain  
Velcro fixing

Corpo de papel, resina e óxido de alumínio  
Microperforado  
Grano semiabierto  
Fixação com velcro

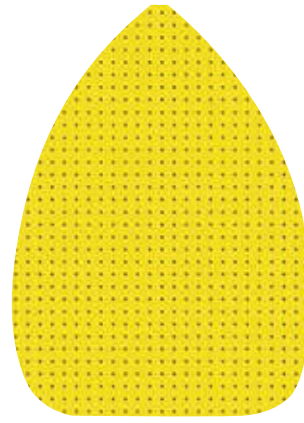

	<b>WK302230</b> 100 / 005-002.000	<b>WK302240</b> 100 / 005-002.000	<b>WK302250</b> 100 / 005-002.000
	80 X 140 X 140 MM	80 X 140 X 140 MM	80 X 140 X 140 MM
	60	80	120
PCS	10	10	10
	8 4248350 010409	8 4248350 010416	8 4248350 010423

**Hoja lija**  
Sanding sheet  
Folha lixa

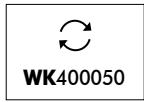

**Cuerpo de papel, resina y óxido de aluminio**  
**Microperforado**  
**Grano semiabierto**  
**Fijación con clip de ajuste**

Paper, resin and aluminium-oxyde body  
Microperforated  
Semi-open grain  
Adjustment clip fixing

Corpo de papel, resina e óxido de alumínio  
Microperforado  
Grano semiabierto  
Fixação com clipe de ajuste

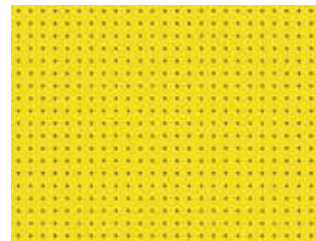

	<b>WK300330</b> 50 / 005-002.400	<b>WK300340</b> 50 / 005-002.400	<b>WK300350</b> 50 / 005-002.400
	110 X 140 MM	110 X 140 MM	110 X 140 MM
	60	80	120
PCS	10	10	10
	8 4248350 010317	8 4248350 010324	8 4248350 010331

**Hoja lija**  
Sanding sheet  
Folha lixa



**Cuerpo de papel, resina y óxido de aluminio**  
**Microperforado**  
**Grano semiabierto**  
**Fijación con clip de ajuste**

Paper, resin and aluminium-oxyde body  
Microperforated  
Semi-open grain  
Adjustment clip fixing

Corpo de papel, resina e óxido de alumínio  
Microperforado  
Grano semiaberto  
Fixação com clipe de ajuste



	<b>WK301310</b> 50 / 005-003.000	<b>WK301320</b> 50 / 005-003.000	<b>WK301330</b> 50 / 005-003.000
	90 X 230 MM	90 X 230 MM	90 X 230 MM
	60	80	120
PCS	10	10	10
	8 4248350 010348	8 4248350 010355	8 4248350 010362

**Hoja lija**  
Sanding sheet  
Folha lixa

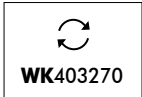

**Cuerpo de papel, resina y óxido de aluminio**  
**Microperforado**  
**Grano semiabierto**  
**Fijación con clip de ajuste**

Paper, resin and aluminium-oxyde body  
Microperforated  
Semi-open grain  
Adjustment clip fixing

Corpo de papel, resina e óxido de alumínio  
Microperforado  
Grano semiaberto  
Fixação com clipe de ajuste

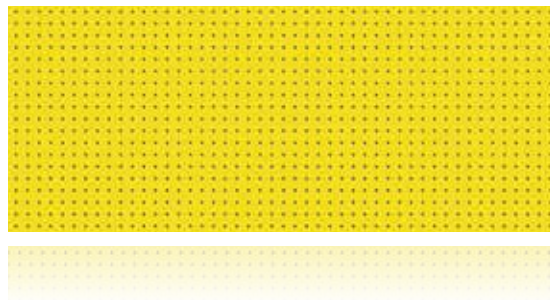

	<b>WK300630</b> 50 / 05-005.500	<b>WK300640</b> 50 / 05-005.500	<b>WK300650</b> 50 / 05-005.500
	115 X 280 MM	115 X 280 MM	115 X 280 MM
	60	80	120
PCS	10	10	10
	8 4248350 010379	8 4248350 010386	8 4248350 010393

# Caperuza pulido

## Polish bonnet

Carapuça polido

Cuerpo de poliéster y algodón

Fijación con velcro



Polyester and cotton body

Velcro fixing

Corpo de poliéster e algodão

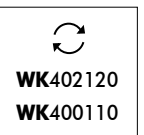
Fixação com velcro



	<b>WK302690</b> 6 / 006-003.900
	180 MM
	8 424835 001230

## Hoja sierra corte madera

### Wood cutting sawblade

Lâmina serra corte madeira

**Cuerpo de acero de alto carbono**  
**Fijación tipo universal**

High carbon steel body  
Universal type fixing

Corpo de aço de alto carbono  
Fixação tipo universal



WK403160  
WK401030



⊙ ⊥	<b>WK300190</b> 6 / 006-003.600
↕	150 MM
↔	10 MM
PCS	5
	8 424835 003333

## Hoja sierra corte metal

### Metal cutting sawblade

Lâmina serra corte metal

**Cuerpo de acero de alto carbono**  
**Fijación tipo universal**

High carbon steel body  
Universal type fixing

Corpo de aço de alto carbono  
Fixação tipo universal



WK403160  
WK401030



⊙ ⊥	<b>WK302170</b> 6 / 006-005.200
↕	105 MM
↔	14 MM
PCS	5
	8 424835 004507

## Hoja sierra corte madera

### Wood cutting sawblade

Lâmina serra corte madeira

**Cuerpo de acero de alto carbono**  
**Fijación tipo T**

High carbon steel body  
T type fixing

Corpo de aço de alto carbono  
Fixação tipo T



WK400950



⊙ ⊥	<b>WK300180</b> 6 / 006-002.400
↕	115 MM
↔	8 MM
PCS	5
	8 424835 008192

## Hoja sierra corte metal

### Metal cutting sawblade

Lâmina serra corte metal

**Cuerpo de acero de alto carbono**  
**Fijación tipo T**

High carbon steel body  
T type fixing

Corpo de aço de alto carbono  
Fixação tipo T



WK400950



⊙ ⊥	<b>WK300170</b> 6 / 006-003.800
↕	80 MM
↔	8 MM
PCS	5
	8 424835 008185

## Atornillador inalámbrico

### Cordless driver

Aparafusador sem fios

#### Cuerpo de ABS

Agarre ergonómico antideslizante

Función de rotación reversible

Indicador LED de carga de batería

Luz LED integrada

Portapuntas imantado

Función de taladrado (sin percusión)

Incluye 23 brocas/puntas

Incluye maletín de transporte

ABS body

Ergonomic non-slip grip

Reversible rotation function

Battery charge LED indicator

Integrated LED light

Magnetic bit holder

Drill function (without impact)

Includes 23 drill-bits/bits

Includes transportation case

Corpo de ABS

Agarramento ergonômico antiderrapante

Função de rotação reversível

Indicador LED de carga da bateria

Luz LED integrada











Porta-pontas magnético

Função de perfuração (sem percussão)

Inclui 23 brocas/pontas

Inclui mala de transporte



	<b>WK400270</b> 10 / 001-018.500
	3.6V ≈ 2.0 AH LI-ON
	3-5 H
	180 RPM
	HEX-6
	≤ 20 MM
	≤ 8 MM
	≤ 8 MM
	CE
	8 424835 009236

## Atornillador percutor inalámbrico

### Cordless impact driver

Aparafusador percussor sem fios

#### Cuerpo de ABS

Agarre ergonómico antideslizante

Función de rotación reversible

Indicador LED de carga de batería

Luz LED integrada

Cabezal graduable

Función de taladrado (con percusión)

Incluye 2 baterías

Incluye 2 puntas

ABS body

Ergonomic non-slip grip

Reversible rotation function

Battery charge LED indicator

Integrated LED light

Adjustable head

Drill function (with impact)

Includes 2 batteries

Includes 2 bits

Corpo de ABS

Agarramento ergonômico

Função de rotação rev

Indicador LED de carga

Luz LED integrada













Cabeçal ajustável

Função de perfuração (

Inclui 2 baterias

Inclui 2 pontas



	<b>WK401040</b> 10 / 001-032.000
	7.2V ≈ 2.0 AH LI-ON
	1.5 H
	0-2300 RPM
	0-3000 IPM
	HEX-6
	≤ 20 MM
	≤ 8 MM
	≤ 5 MM
	≤ 8 MM
	CE
	8 424835 009748

# Atornillador yeso Drywall screwdriver

Aparafusador gesso

**Cuerpo de ABS y aluminio**

**Interruptor con botón de funcionamiento continuo**

**Agarre ergonómico antideslizante**

**Función de rotación reversible**

**Regulador de profundidad**

**Clip de sujeción para el cinturón**

**Portapuntas imantado**

**Incluye correa de sujeción**

ABS and aluminium body

Switch with continuous operation button

Ergonomic non-slip grip

Reversible rotation function

Depth regulator

Fastening belt clip

Magnetic bit holder

Includes clamping strap

Corpo de ABS e alumínio

Interruptor com botão de operação contínua

Agarramento ergonômico antiderrapante

Função de rotação reversível









Regulador de profundidade

Clipe de sujeição para o cinto

Porta-pontas magnético

Inclui correia de sujeição



	<b>WK400090</b> 6 / 001-039.600
	550 W
	0-4500 RPM
	HEX-6
	6 MM
	0-20 MM
	CE
	8 424835 001681

# Taladro atornillador inalámbrico

## Cordless driver drill

Berbequim aparafusador sem fios

**Cuerpo de ABS**

**Agarre ergonómico antideslizante**

**Selector de 2 rangos de revoluciones**

**Función de rotación reversible**

**Indicador LED de carga de batería**

**Luz LED integrada**

**Portabrocas automático**

**Función de taladrado (sin percusión)**

**Clip de sujeción para el cinturón**

**Incluye 2 baterías**

**Incluye maletín de transporte**

ABS body

Ergonomic non-slip grip

2-speed range selector

Reversible rotation function

Battery charge LED indicator

Integrated LED light

Keyless chuck

Drill function (without impact)

Fastening belt clip

Includes 2 batteries

Includes transportation case

Corpo de ABS

Agarramento ergonómico antiderrapante

Selector de 2 níveis de rotações

Função de rotação reversível

Indicador LED de carga da bateria

Luz LED integrada

Bucha automática











Função de perfuração (sem percussão)

Clipe de sujeição para o cinto

Inclui 2 baterias

Inclui mala de transporte



	<b>WK400280</b> 5 / 001-042.000
	12V = 2.0 AH LI-ON
	1.5 H
	0-350 / 0-1100 RPM
	17+1
	≤ 10 MM
	≤ 20 MM
	≤ 8 MM
	6 MM
	CE
	8 424835 009243

# Taladro atornillador-percutor inalámbrico

## Cordless impact-driver drill

Berbequim aparafusador-percussor sem fios

**Cuerpo de ABS**

**Agarre ergonómico antideslizante**

**Selector de 2 rangos de revoluciones**

**Función de rotación reversible**

**Indicador LED de carga de batería**

**Luz LED integrada**

**Portabrocas automático metálico**

**Función de taladrado (con y sin percusión)**

**Clip de sujeción para el cinturón**

**Incluye 2 baterías**

**Incluye maletín de transporte**

ABS body

Ergonomic non-slip grip

2-speed range selector

Reversible rotation function

Battery charge LED indicator

Integrated LED light

Metallic keyless chuck

Drill function (with and without impact)

Fastening belt clip

Includes 2 batteries

Includes transportation case

Corpo de ABS

Agarramento ergonómico antiderrapante

Selector de 2 níveis de rotações

Função de rotação reversível

Indicador LED de carga da bateria

Luz LED integrada

Bucha automática metálica













Função de perfuração (com e sem percussão)

Clipe de sujeição para o cinto

Inclui 2 baterias

Inclui mala de transporte



	<b>WK400290</b> 4 / 001-079.800
	20V = 2.0 AH LI-ION
	1.5 H
	0-400 / 0-1400 RPM
	0-4550 / 0-18200 IPM
	18+2
	≤ 13 MM
	≤ 32 MM
	≤ 13 MM
	≤ 12 MM
	6 MM
	CE
	8 424835 009250



# Taladro percutor

## Impact drill

Berbequim percussor

### Cuerpo de ABS

Agarre ergonómico antideslizante

Mango auxiliar orientable

Regulador de velocidad

Función de rotación reversible

Portabrocas automático

Interruptor con botón de funcionamiento continuo

Función de taladrado (con y sin percusión)

ABS body

Ergonomic non-slip grip

Adjustable auxiliary handle

Speed regulator

Reversible rotation function

Keyless chuck

Switch with continuous operation button

Drill function (with and without impact)

Corpo de ABS

Agarramento ergonómico antiderrapante

Cabo auxiliar orientável

Regulador de velocidade











Função de rotação reversível

Bucha automática

Interruptor com botão de operação contínua

Função de perfurado (com e sem percussão)



	<b>WK401530</b> 10 / 001-026.500
	700 W
	0-3000 RPM
	0-48000 IPM
	2-13 MM
	≤ 30 MM
	≤ 13 MM
	≤ 13 MM
	CE
	8 424835 007997

## Taladro martillo percutor

### Impact hammer drill

Berbequim martelo percussor

**Cuerpo de ABS y aluminio**

**Agarre ergonómico antideslizante**

**Mango auxiliar orientable**

**Regulador de velocidad**

**Selector de 2 rangos de revoluciones**

**Función de rotación reversible**

**Portabrocas automático**

**Interruptor con botón de funcionamiento continuo**

**Función de taladrado (con y sin percusión)**

ABS and aluminium body

Ergonomic non-slip grip

Adjustable auxiliary handle

Speed regulator

2-speed range selector

Reversible rotation function

Keyless chuck

Switch with continuous operation button

Drill function (with and without impact)

Corpo de ABS e alumínio

Agarramento ergonômico antiderrapante

Cabo auxiliar orientável

Regulador de velocidade

Selector de 2 níveis de rotações











Função de rotação reversível

Bucha automática

Interruptor com botão de operação contínua

Função de perfurado (com e sem percussão)



	<b>WK403170</b> 5 / 001-048.500
	1050 W
	0-1100 / 0-3000 RPM
	0-52300 IPM
	2-13 MM
	≤ 40 MM
	≤ 16 MM
	≤ 20 MM
	CE
	8 424835 006617

# Taladro martillo demoledor

## Demolition hammer drill

Berbequim martelo demolidor

**Cuerpo de ABS y aluminio**

**Interruptor con botón de funcionamiento continuo**

**Agarre ergonómico antideslizante**

**Mango auxiliar orientable**

**Mango con protector de puño**

**Regulador de velocidad**

**Función de rotación reversible**

**Función de taladrado (con y sin percusión)**

**Función de cincelado (con y sin giro)**

**Incluye 2 cinceles y 3 brocas**

**Incluye maletín de transporte**

ABS and aluminium body

Switch with continuous operation button

Ergonomic non-slip grip

Adjustable auxiliary handle

Fist protector handle

Speed regulator

Reversible rotation function

Drill function (with and without impact)

Chisel function (with and without spin)

Includes 2 chisels and 3 drill-bits

Includes transportation case

Corpo de ABS e alumínio

Interruptor com botão de operação contínua

Agarramento ergonômico antiderrapante

Cabo auxiliar orientável

Cabo com protector de punho

Regulador de velocidade

Função de rotação reversível











Função de perfuração (com e sem percussão)

Função de cincelado (com e sem virada)

Inclui 2 cinzeis e 3 brocas

Inclui mala de transporte



	<b>WK402240</b> 4 / 001-076.800
	1050 W
	0-1100 RPM
	0-4900 IPM
	3 J
	SDS PLUS
	≤ 40 MM
	≤ 16 MM
	≤ 26 MM
	CE
	8 424835 007119

# Taladro martillo demoledor inalámbrico

## Cordless demolition hammer drill

Berbequim martelo demolidor sem fios

**Cuerpo de ABS y aluminio**

**Motor sin escobillas**

**Agarre ergonómico antideslizante**

**Mango auxiliar orientable**

**Mango con protector de puño**

**Función de rotación reversible**

**Función de taladrado (con y sin percusión)**

**Función de cincelado (con y sin giro)**

**Luz LED integrada**

**Incluye 2 cinceles y 3 brocas**

**Incluye 2 baterías**

**Incluye maletín de transporte**

ABS and aluminium body

Brushless motor

Ergonomic non-slip grip

Adjustable auxiliary handle

Fist protector handle

Reversible rotation function

Drill function (with and without impact)

Chisel function (with and without spin)

Integrated LED light

Includes 2 chisels and 3 drill-bits

Includes 2 batteries

Includes transportation case

Corpo de ABS e alumínio

Motor sem escovas

Agarramento ergonómico antiderrapante

Cabo auxiliar orientável

Cabo com protector de punho

Função de rotação reversível

Função de perfuração (com e sem percussão)

Função de cincelado (com e sem virada)

Luz LED integrada

Inclui 2 cinzeis e 3 brocas

Inclui 2 baterias

Inclui mala de transporte



	<b>WK401630</b> 4 / 001-142.000
	20V = 4.0 AH LI-ON
	2 H
	0-1150 RPM
	0-4700 IPM
	3 J
	SDS PLUS
	≤ 34 MM
	≤ 14 MM
	≤ 18 MM
	CE
	8424835 010287

## Taladro martillo demoledor

### Demolition hammer drill

Berbequim martelo demolidor

**Cuerpo de ABS y aluminio**

**Agarre ergonómico antideslizante**

**Mango auxiliar orientable**

**Mango con protector de puño**

**Selector de velocidades**

**Función de taladrado (con percusión)**

**Función de cincelado (con y sin giro)**

**Sistema antivibración**

**Incluye broca y cincel**

**Incluye maletín de transporte**

ABS and aluminium body

Ergonomic non-slip grip

Adjustable auxiliary handle

Fist protector handle

Speed selector

Drill function (with impact)

Chisel function (with and without spin)

Anti-vibration system

Includes drill-bit and chisel

Includes transportation case

Corpo de ABS e alumínio

Agarramento ergonômico antiderrapante

Cabo auxiliar orientável

Cabo com protector de punho

Selector de velocidades

Função de perfurado (com percussão)











Função de cincelado (com e sem virada)

Sistema antivibração

Inclui broca e cincel

Inclui mala de transporte



	<b>WK401020</b> 2 / 001-173.500
	1100 W
	300-760 RPM
	1950-4850 IPM
	6
	7 J
	SDS MAX
	≤ 35 MM
	CE
	8 424835 009267

## Martillo demoledor

### Demolition hammer

Martelo demolidor

**Cuerpo de ABS y aluminio**

**Agarre ergonómico antideslizante**

**Mango auxiliar orientable**

**Mango con protector de puño**

**Interruptor de funcionamiento continuo**

**Selector de velocidades**

**Función de cincelado (con y sin giro)**

**Sistema antivibración**

**Incluye cincel**

**Incluye maletín de transporte**

ABS and aluminium body

Ergonomic non-slip grip

Adjustable auxiliary handle

Fist protector handle

Continuous operation switch

Speed selector

Chisel function (with and without spin)

Anti-vibration system

Includes chisel

Includes transportation case

Corpo de ABS e alumínio

Agarramento ergonômico antiderrapante

Cabo auxiliar orientável

Cabo com protector de punho

Interruptor de operação contínua

Selector de velocidades









Função de cincelado (com e sem virada)

Sistema antivibração

Inclui cincel

Inclui mala de transporte



	<b>WK400610</b> 2 / 001-162.000
	1200 W
	2700-3700 IPM
	6
	14 J
	SDS MAX
	CE
	8 424835 007058

## Martillo demoledor

### Demolition hammer

Martelo demolidor

**Cuerpo de ABS y aluminio**

**Agarre ergonómico antideslizante**

**Mango auxiliar orientable**

**Mango con protector de puño**

**Interruptor de funcionamiento continuo**

**Selector de velocidades**

**Función de cincelado (con y sin giro)**

**Sistema antivibración**

**Incluye cincel**

**Incluye maletín de transporte**

ABS and aluminium body

Ergonomic non-slip grip

Adjustable auxiliary handle

Fist protector handle

Continuous operation switch

Speed selector

Chisel function (with and without spin)

Anti-vibration system

Includes chisel

Includes transportation case

Corpo de ABS e alumínio

Agarramento ergonômico antiderrapante

Cabo auxiliar orientável

Cabo com protector de punho

Interruptor de operação contínua

Selector de velocidades

Função de cincelado (com e sem virada)

Sistema antivibração

Inclui cinzel

Inclui mala de transporte



	<b>WK400240</b> 1 / 001-222.000
	1500 W
	1000-1900 IPM
	6
	25 J
	SDS MAX
	CE
	8 424835 007713

## Martillo demoledor

### Demolition hammer

Martelo demolidor

**Cuerpo de ABS y aluminio**

**Interruptor de funcionamiento continuo**

**Agarre ergonómico antideslizante**

**Mango auxiliar orientable**

**Mango con protector de puño**

**Sistema antivibración**

**Función de cincelado (sin giro)**

**Incluye cincel y puntero**

**Incluye maletín de transporte**

ABS and aluminium body

Continuous operation switch

Ergonomic non-slip grip

Adjustable auxiliary handle

Fist protector handle

Anti-vibration system

Chisel function (without spin)

Includes chisel and pointer

Includes transportation case

Corpo de ABS e alumínio

Interruptor de operação contínua

Agarramento ergonômico antiderrapante

Cabo auxiliar orientável

Cabo com protector de punho







Sistema antivibração

Função de cincelado (sem virada)

Inclui cincel e ponteiro

Inclui mala de transporte



	<b>WK400310</b> 1 / 001-243.500
	1500 W
	1400 IPM
	50 J
	HEX-30
	CE
	8 424835 009274

## Martillo demoledor

### Demolition hammer

Martelo demolidor

**Cuerpo de ABS y aluminio**

**Interruptor de funcionamiento continuo**

**Agarre ergonómico antideslizante**

**Mango auxiliar orientable**

**Mango con protector de puño**

**Sistema antivibración**

**Función de cincelado (sin giro)**

**Incluye cincel y puntero**

**Incluye maletín de transporte**

ABS and aluminium body

Continuous operation switch

Ergonomic non-slip grip

Adjustable auxiliary handle

Fist protector handle

Anti-vibration system

Chisel function (without spin)

Includes chisel and pointer

Includes transportation case

Corpo de ABS e alumínio

Interruptor de operação contínua

Agarramento ergonômico antiderrapante

Cabo auxiliar orientável

Cabo com protector de punho

Sistema antivibração

Função de cincelado (sem virada)

Inclui cinzel e ponteiro

Inclui mala de transporte



	<b>WK403180</b> 1 / 001-309.000
	1600 W
	1450 IPM
	60 J
	HEX-30
	CE
	8 424835 009656



## Martillo demoledor

### Demolition hammer

Martelo demolidor

**Cuerpo de ABS y aluminio**

**Agarre ergonómico antideslizante**

**Función de cincelado (sin giro)**

**Sistema antivibración**

**Incluye cincel y puntero**

**Incluye maletín de transporte**

ABS and aluminium body

Ergonomic non-slip grip

Chisel function (without spin)

Anti-vibration system

Includes chisel and pointer

Includes transportation case

Corpo de ABS e alumínio

Agarramento ergonômico antiderrapante







Função de cincelado (sem virada)

Sistema antivibração

Inclui cinzel e ponteiro

Inclui mala de transporte



	<b>WK403200</b> 1 / 001-569.000
	2200 W
	950 IPM
	80 J
	HEX-28
	CE
	8 424835 009670

## Carro martillo demoledor

### Demolition hammer trolley

Carro martelo demolidor

**Cuerpo de acero carbono**

**Ruedas de PU de 200 mm**

**Incluye 4 portacinceles/punteros**

Carbon steel body

PU wheels of 200 mm

Includes 4 chisel/pointer holders

Corpo de aço carbono

Rodas de PU de 200 mm

Inclui 4 porta-cinzeis/ponteiros



WK403200

	<b>WK403190</b> 1 / 001-075.600
	135 KG
	1065 MM
	485 MM
	8 424835 009663

## Expositor martillos demoledores

### Demolition hammer display stand

Expositor martelos demolidores

**Cuerpo de acero carbono**

**Capacidad de 9 martillos demoledores**

Carbon steel body

Capacity of 9 demolition hammers

Corpo de aço carbono

Capacidade de 9 martelos demolidores



WK402240

WK401020

WK400610

WK400240

WK400310

WK403180

WK403200

	<b>WK400230</b> 1 / 001-070.400
	1500 MM
	640 MM
	8 424835 009519

## Soporte polipasto

### Hoist frame

Suporte garibalde

**Cuerpo de acero inoxidable**

**Compatible con polipastos eléctricos universales**

**Compatible con andamios de estructura redonda universales**

Stainless-steel body

Compatible with universal electric hoists

Compatible with universal round frame scaffolds

Corpo de aço inoxidável

Compatível com garibaldes elétricos universais

Compatível com andaimes de armação redonda universais



**WK400160**

**WK400170**

**WK400220**

**WK400540**

**WK400550**



	<b>WK400510</b> 4 / 001-036.500
	600 KG
	750 MM
	48 MM
	TÜV GS
	8 424835 000714

## Polipasto cable

### Cable hoist





Garibalde cabo

**Cuerpo de aluminio y acero carbono**  
**Interruptor de seguridad electromagnético**  
**Gancho de seguridad con contrapeso**  
**Sistema con polea de reenvío**  
**Incluye abrazaderas de soporte**

Aluminium and carbon steel body  
 Electromagnetic safety switch  
 Counterweight safety hook  
 Forward-pulley system  
 Includes support brackets

Corpo de alumínio e aço carbono  
 Interruptor de segurança eletromagnético  
 Gancho de segurança com contrapeso  
 Sistema com roldana de reenvio  
 Inclui braçadeiras de suporte



	<b>WK400160</b> 2 / 001-092.500	<b>WK400170</b> 2 / 001-122.000	<b>WK400220</b> 2 / 001-164.000	<b>WK400540</b> 2 / 001-225.000	<b>WK400550</b> 1 / 001-287.400
	100 KG / 200 KG	200 KG / 400 KG	300 KG / 600 KG	400 KG / 800 KG	500 KG / 1000 KG
	450 W	750 W	1050 W	1350 W	1600 W
	2500 RPM	2500 RPM	2500 RPM	2500 RPM	2500 RPM
	8 MPM / 4 MPM	8 MPM / 4 MPM	10 MPM / 5 MPM	10 MPM / 5 MPM	8 MPM / 4 MPM
	18 M / 9 M	22 M / 11 M	22 M / 11 M	22 M / 11 M	22 M / 11 M
	18 M	22 M	22 M	22 M	22 M
	3 MM	3.8 MM	4.5 MM	5 MM	5.6 MM
	CE	CE	CE	CE	CE
	8 424835 505042	8 424835 510053	8 424835 510046	8 424835 000738	8 424835 000745

## Proyector LED luz trabajo

### Work light LED projector

### Projetor LED luz trabalho

Cuerpo de aluminio y acero carbono

Agarre ergonómico antideslizante

Compatible para uso interior y exterior

Base graduable

Aluminium and carbon steel body

Ergonomic non-slip grip

Compatible for indoor and outdoor use

Adjustable base

Corpo de alumínio e aço carbono

Agarramento ergonómico antiderrapante

Compatível para uso interior e exterior

Base graduável



	<b>WK402150</b> 4 / 001-034.000	<b>WK402160</b> 4 / 001-044.000	<b>WK403210</b> 2 / 001-075.500	<b>WK403220</b> 2 / 001-096.500
	30 W	50 W	100 W	150 W
	SMD / 72 X EPISTAR	SMD / 120 X EPISTAR	SMD / 240 X EPISTAR	SMD / 360 X EPISTAR
	2700 LM	4500 LM	9000 LM	11000 LM
	6500 K	6500 K	6500 K	6500 K
	130°	130°	130°	130°
	20 M	30 M	40 M	50 M
	200 X 170 X 60 MM	240 X 200 X 60 MM	280 X 250 X 80 MM	360 X 290 X 80 MM
	10000 H	10000 H	10000 H	10000 H
	CE	CE	CE	CE
	8 424835 008000	8 424835 008017	8 424835 009038	8 424835 009045

## Enrollacables alargador

### Cable roller extension

Enrola cabos prolongador

**Cuerpo de aluminio y acero carbono**

**Agarre ergonómico antideslizante**

**Compatible para uso interior**

**Protección de sobrecalentamiento**

**Sistema de protección infantil**

**Manivela de recogida**

Aluminium and carbon steel body

Ergonomic non-slip grip

Compatible for indoor use

Overheat protection

Child protection system

Roller handle

Corpo de alumínio e aço carbono

Agarramento ergonômico antiderrapante

Compatível para uso interior

Proteção de sobreaquecimento

Sistema de proteção infantil

Manivela de recolhida



	<b>WK402420</b> 1 / 001-029.900	<b>WK402430</b> 1 / 001-049.900
	25 M	50 M
	4	4
	H05VV-F 3G1.5MM <sup>2</sup>	H05VV-F 3G1.5MM <sup>2</sup>
	≤ 3500 W	≤ 3500 W
	CE	CE
	8 424835 008161	8 424835 008178

# Hidrolavadora alta presión

## High pressure washer

Lavadora alta pressão

**Cuerpo de ABS y aluminio**

**Agarre ergonómico antideslizante**

**Mango con protector de puño**

**Motor sin escobillas**

**Incluye manguera de alta presión de 5 metros**

**Incluye pistola con lanza**

ABS and aluminium body

Ergonomic non-slip grip

Fist protector handle

Brushless motor

Includes 5-meter high pressure hose

Includes gun with lance

Corpo de ABS e alumínio

Agarramento ergonómico antiderrapante

Cabo com protector de punho

Motor sem escovas

Inclui manguêira de alta pressão de 5 metros

Inclui pistola com lança



	<b>WK400890</b> 1 / 001-092.800
	1300 W
	2800 RPM
	70 BAR
	100 BAR
	6 LPM
	6.5 LPM
	≤ 50° C
	CE
	8 424835 009564

## Hidrolavadora alta presión

### High pressure washer

Lavadora alta pressão

**Cuerpo de ABS, aluminio y acero carbono**

**Ruedas de ABS de 170 mm**

**Agarre ergonómico antideslizante**

**Mango con protector de puño**

**Función de absorción directa de químicos**

**Motor sin escobillas**

**Incluye manguera de alta presión de 8 metros**

**Incluye pistola con lanza**

**Incluye boquillas de 0, 15 y 40 grados**

ABS, aluminium and carbon steel body

ABS wheels of 170 mm

Ergonomic non-slip grip

Fist protector handle

Direct chemical absorption function

Brushless motor

Includes 8-meter high pressure hose

Includes gun with lance

Includes 0, 15- and 40-degree nozzles

Corpo de ABS, alumínio e aço carbono

Rodas de ABS de 170 mm

Agarramento ergonômico antiderrapante

Cabo com protector de punho

Função de absorção direta de produtos químicos

Motor sem escovas

Inclui mangueira de alta pressão de 8 metros

Inclui pistola com lança

Inclui boquilhas de 0, 15 e 40 graus



## Hidrolavadora alta presión

### High pressure washer

Lavadora alta pressão

**Cuerpo de ABS, aluminio y acero carbono**

**Ruedas de caucho de 200 mm**

**Agarre ergonómico antideslizante**

**Mango con protector de puño**

**Función de absorción directa de químicos**

**Motor sin escobillas**

**Incluye manguera de alta presión de 8 metros**

**Incluye pistola con lanza**

**Incluye boquillas de 0, 15, 40 y 60 grados**

ABS, aluminium and carbon steel body

Rubber wheels of 200 mm

Ergonomic non-slip grip

Fist protector handle

Direct chemical absorption function

Brushless motor

Includes 8-meter high pressure hose

Includes gun with lance

Includes 0, 15, 40- and 60-degree nozzles

Corpo de ABS, alumínio e aço carbono

Rodas de borracha de 200 mm

Agarramento ergonômico antiderrapante

Cabo com protector de punho

Função de absorção direta de produtos químicos

Motor sem escovas

Inclui mangueira de alta pressão de 8 metros

Inclui pistola com lança

Inclui boquilhas de 0, 15, 40 e 60 graus



	<b>WK400710</b> 1 / 001-366.000
	2200 W
	2900 RPM
	80 BAR
	120 BAR
	10.5 LPM
	12 LPM
	≤ 50° C
	CE
	8 424835 009540

	<b>WK400720</b> 1 / 001-596.000
	3700 W
	2900 RPM
	180 BAR
	200 BAR
	7 LPM
	9.5 LPM
	≤ 50° C
	CE
	8 424835 009557





# Herramientas manuales

## Hand tools

Ferramentas manuais



## Pistola cartuchos skeleton

### Skeleton caulking gun

Pistola cartuchos skeleton

**Cuerpo de aluminio y acero carbono**  
**Varilla interior de alta aleación**  
**Émbolo reforzado de 4 mm**  
**Compatible con cartuchos universales**  
**Función anti-goteo**

Aluminium and carbon steel body  
High alloy inner rod  
Reinforced piston of 4 mm  
Compatible with universal cartridges  
No-drip function

Corpo de alumínio e aço carbono  
Varinha interna de alta liga  
Êmbolo reforçado de 4 mm  
Compatível com cartuchos universais  
Função anti-gotejamento



## Pistola cartuchos

### Caulking gun







Pistola cartuchos







**Cuerpo de aluminio y acero carbono**  
**Varilla interior de alta aleación**  
**Émbolo reforzado de 9 mm**  
**Mango y gatillo reforzados**  
**Compatible con cartuchos universales**  
**Función anti-goteo**

Aluminium and carbon steel body  
High alloy inner rod  
Reinforced piston of 9 mm  
Reinforced handle and trigger  
Compatible with universal cartridges  
No-drip function

Corpo de alumínio e aço carbono  
Varinha interna de alta liga  
Punho e gatilho reforçados  
Êmbolo reforçado de 9 mm  
Compatível com cartuchos universais  
Função anti-gotejamento



	<b>WK602410</b> 24 / 001-002.800
	300 ML
	50 MM
	225 MM
	1500 N
	26:1
	8 424835 009953

	<b>WK602420</b> 12 / 001-006.200
	300 ML
	50 MM
	225 MM
	1800 N
	12:1
	8 424835 009960

## Pistola cartuchos

### Caulking gun

Pistola cartuchos

**Cuerpo de aluminio y acero carbono**  
**Varilla interior de alta aleación**  
**Émbolo reforzado de 10 mm**  
**Mango y gatillo reforzados**  
**Compatible con cartuchos universales**  
**Función anti-goteo**

Aluminium and carbon steel body  
 High alloy inner rod  
 Reinforced piston of 10 mm  
 Reinforced handle and trigger  
 Compatible with universal cartridges  
 No-drip function

Corpo de alumínio e aço carbono  
 Varinha interna de alta liga  
 Punho e gatilho reforçados  
 Êmbolo reforçado de 10 mm  
 Compatível com cartuchos universais  
 Função anti-gotejamento



## Pistola cartuchos tubular

### Tubular caulking gun

Pistola cartuchos tubular

**Cuerpo de aluminio**  
**Varilla interior de alta aleación**  
**Émbolo reforzado de 9 mm**  
**Mango y gatillo reforzados**  
**Grosor tubo aluminio de 1 mm**  
**Compatible con cartuchos universales**  
**Función anti-goteo**  
**Incluye boquilla**

Aluminium body  
 High alloy inner rod  
 Reinforced piston of 9 mm  
 Reinforced handle and trigger  
 Aluminium tube thickness of 1 mm  
 Compatible with universal cartridges  
 No-drip function  
 Includes nozzle

Corpo de alumínio  
 Varinha interna de alta liga  
 Punho e gatilho reforçados  
 Êmbolo reforçado de 9 mm  
 Espessura do tubo de alumínio de 1 mm  
 Compatível com cartuchos universais  
 Função anti-gotejamento  
 Inclui boquilha



	<b>WK602430</b> 12 / 001-008.800
	300 ML
	50 MM
	225 MM
	4000 N
	26:1
	8 424835 009977

	<b>WK602440</b> 12 / 001-008.200	<b>WK602450</b> 12 / 001-009.500
	300 ML	600 ML
	50 MM	50 MM
	225 MM	375 MM
	2500 N	2500 N
	18:1	18:1
	8 424835 009984	8 424835 009991

# Espátula

## Scraper

Espátula

**Cuerpo de acero inoxidable**

**Mango de ABS**

**Tope de golpe metálico**

**Agarre ergonómico antideslizante**

Stainless-steel body

ABS handle

Metallic hit end

Ergonomic non-slip grip

Corpo de aço inoxidável

Cabo de ABS

Tope de golpe metálico

Agarramento ergonómico antiderrapante



Ø I	<b>WK600280</b> 12 / 012-001.200	<b>WK600290</b> 12 / 012-001.250	<b>WK600300</b> 12 / 012-001.300	<b>WK600310</b> 12 / 012-001.350
↔	20 MM	30 MM	40 MM	50 MM
↑ ↓	90 MM	90 MM	90 MM	90 MM
∨ ∧	0.5 MM	0.5 MM	0.5 MM	0.5 MM
	8 424835 003715	8 424835 001452	8 424835 001469	8 424835 001476

Ø I	<b>WK600320</b> 12 / 012-001.400	<b>WK600330</b> 12 / 012-001.450	<b>WK600340</b> 12 / 012-001.500	<b>WK600350</b> 12 / 012-001.550	<b>WK600360</b> 12 / 012-001.600
↔	60 MM	70 MM	80 MM	90 MM	100 MM
↑ ↓	100 MM	100 MM	100 MM	100 MM	100 MM
∨ ∧	0.5 MM	0.5 MM	0.5 MM	0.5 MM	0.5 MM
	8 424835 002282	8 424835 002275	8 424835 000165	8 424835 000172	8 424835 000189

## Espátula multifunción

### Multi-function scraper

Espátula multifunção

**Cuerpo de acero inoxidable**

**Mango de ABS**

**Tope de golpe metálico**

**Agarre ergonómico antideslizante**

Stainless-steel body

ABS handle

Metallic hit end

Ergonomic non-slip grip

Corpo de aço inoxidável

Cabo de ABS

Tope de golpe metálico

Agarramento ergonómico antiderrapante



	<b>WK600270</b> 12 / 012-001.600
	70 MM
	110 MM
	0.5 MM
	8 424835 003708

## Espátula yeso

### Drywall scraper

Espátula gesso

**Cuerpo de acero inoxidable - Mango de ABS**

**Puntas de atornillado de CV**

**Puntas de atornillado magnéticas**

**Tope de golpe metálico**

**Agarre ergonómico antideslizante**

**Incluye 2 puntas de atornillado**

Stainless-steel body - ABS handle

CV screw bits

Magnetic screw bits

Metallic hit end

Ergonomic non-slip grip

Includes 2 screw bits

Corpo de aço inoxidável - Cabo de ABS

Puntas de aparafusado de CV

Puntas de aparafusado magnéticas

Tope de golpe metálico

Agarramento ergonómico antiderrapante

Inclui 2 puntas de aparafusado



	<b>WK601700</b> 12 / 006-002.800
	150 MM
	110 MM
	0.5 MM
	8 424835 006815

## Juego espátulas enmasillar

### Putty scraper set

Jogo espátulas enmasillar

**Cuerpo de ABS**

**Agarre antideslizante**

ABS body

Non-slip grip

Corpo de ABS

Agarramento antiderrapante



	<b>WK601540</b> 12 / 006-000.900
	50-120 MM
	110 MM
	3 MM
PCS	4
	8 424835 006310

## Juego espátulas enmasillar

### Putty scraper set

Jogo espátulas enmasillar

**Cuerpo de acero**

**Mango de ABS**

**Agarre antideslizante**

Steel body

ABS handle

Non-slip grip

Corpo de aço

Cabo de ABS

Agarramento antiderrapante



	<b>WK601560</b> 12 / 006-001.800
	50-120 MM
	110 MM
	3 MM
PCS	4
	8 424835 006327

# Espátula emplastecer

## Taping knife

Espátula amassar

**Cuerpo de acero inoxidable**

**Mango y soporte de ABS**

**Agarre ergonómico antideslizante**

Stainless-steel body

ABS handle and support

Ergonomic non-slip grip

Corpo de aço inoxidável

Cabo e suporte de ABS

Agarramento ergonómico antiderrapante



Ø I	<b>WK600370</b> 10 / 010-001.600	<b>WK600380</b> 10 / 010-001.700	<b>WK600390</b> 10 / 010-001.800
↔	120 MM	140 MM	160 MM
↑ ↓	90 MM	90 MM	90 MM
∨ ∧	0.5 MM	0.5 MM	0.5 MM
	8 424835 000509	8 424835 000592	8 424835 000523

Ø I	<b>WK600400</b> 10 / 010-001.900	<b>WK600410</b> 10 / 010-002.000	<b>WK600420</b> 10 / 010-002.100	<b>WK600430</b> 10 / 010-002.200
↔	180 MM	200 MM	220 MM	240 MM
↑ ↓	90 MM	90 MM	90 MM	90 MM
∨ ∧	0.5 MM	0.5 MM	0.5 MM	0.5 MM
	8 424835 000530	8 424835 000585	8 424835 000882	8 424835 000899

## Espátula emplastecer

### Taping knife

Espátula amassar

**Cuerpo de acero inoxidable**

**Mango y soporte de ABS**

**Agarre ergonómico antideslizante**

**Uso lateral izquierda y derecha**

Stainless-steel body

ABS handle and support

Ergonomic non-slip grip

Left and right lateral use

Corpo de aço inoxidável

Cabo e suporte de ABS

Agarramento ergonômico antiderrapante

Uso lateral esquerda e direita



Ø I	<b>WK601820</b> 10 / 005-003.000	<b>WK601830</b> 10 / 005-003.600	<b>WK601840</b> 10 / 005-004.400
←→	200 MM	250 MM	350 MM
↑ ↓	60 MM	60 MM	60 MM
∨ ∧	0.5 MM	0.5 MM	0.5 MM
	8 424835 007683	8 424835 007690	8 424835 007706

## Espátula emplastecer

### Taping knife

Espátula amassar

**Cuerpo de acero azul**

**Mango de ABS y soporte de aluminio**

**Tope de golpe metálico**

**Agarre ergonómico antideslizante**

Blue steel body

ABS handle and aluminium support

Metallic hit end

Ergonomic non-slip grip

Corpo de aço azul

Cabo de ABS e suporte de alumínio

Tope de golpe metálico

Agarramento ergonômico antiderrapante



Ø I	<b>WK602250</b> 6 / 006-002.600	<b>WK602260</b> 6 / 006-003.000	<b>WK602270</b> 6 / 006-003.400	<b>WK602280</b> 6 / 006-003.800	<b>WK602290</b> 6 / 006-004.200
←→	150 MM	200 MM	250 MM	300 MM	350 MM
↑ ↓	90 MM	90 MM	90 MM	90 MM	90 MM
∨ ∧	0.5 MM	0.5 MM	0.5 MM	0.5 MM	0.5 MM
	8 424835 009175	8 424835 009182	8 424835 009199	8 424835 009205	8 424835 009212



## Espátula ángulos exteriores

### Exterior angle trowel

Espátula ângulos exteriores

**Cuerpo de acero inoxidable**

**Mango de ABS**

**Agarre ergonómico antideslizante**

**Juntas con soldadura TIG**

Stainless-steel body

ABS handle

Ergonomic non-slip grip

TIG welding joints

Corpo de aço inoxidável

Cabo de ABS

Agarramento ergonômico antiderrapante

Juntas com soldadura TIG



	<b>WK602330</b> 10 / 001-003.200
	100 MM
	90 MM
	0.5 MM
	8 424835 009632

## Espátula ángulos interiores

### Interior angle trowel

Espátula ângulos interiores

**Cuerpo de acero inoxidable**

**Mango de ABS**

**Agarre ergonómico antideslizante**

**Juntas con soldadura TIG**

Stainless-steel body

ABS handle

Ergonomic non-slip grip

TIG welding joints

Corpo de aço inoxidável

Cabo de ABS

Agarramento ergonômico antiderrapante

Juntas com soldadura TIG



	<b>WK602340</b> 10 / 001-003.200
	100 MM
	90 MM
	0.5 MM
	8 424835 009649

## Llana rectangular

### Rectangular trowel

#### Talocha rectangular

**Cuerpo de acero inoxidable**

**Mango de ABS**

**Agarre ergonómico antideslizante**

**Juntas con soldadura TIG**

Stainless-steel body

ABS handle

Ergonomic non-slip grip

TIG welding joints

Corpo de aço inoxidável

Cabo de ABS

Agarramento ergonômico antiderrapante

Juntas com soldadura TIG



⊙ 	<b>WK600230</b> 12 / 001-003.800	<b>WK601060</b> 12 / 001-004.400
↕	280 MM	300 MM
↔	120 MM	150 MM
∨ ∧	0.7 MM	0.7 MM
	8 424835 002862	8 424835 006129

## Llana decorador

### Decorator trowel

#### Talocha decorador

**Cuerpo de acero inoxidable**

**Mango de ABS**

**Agarre ergonómico antideslizante**

**Juntas con soldadura TIG**

Stainless-steel body

ABS handle

Ergonomic non-slip grip

TIG welding joints

Corpo de aço inoxidável

Cabo de ABS

Agarramento ergonômico antiderrapante

Juntas com soldadura TIG



⊙ 	<b>WK600960</b> 12 / 001-003.400	<b>WK601010</b> 12 / 001-003.600
↕	200 MM	240 MM
↔	80 MM	110 MM
∨ ∧	0.6 MM	0.6 MM
	8 424835 006105	8 424835 006112

## Rascador yeso

### Drywall scraper





Rascador gesso

**Cuerpo de acero carbono - Juntas con soldadura TIG**  
**Agarre ergonómico antideslizante**

Carbon steel body - TIG welding joints  
Ergonomic non-slip grip

Corpo de aço carbono - Juntas com soldadura TIG  
Agarramento ergonómico antiderrapante



	<b>WK600540</b> 10 / 001-005.600
	285 MM
	150 MM
	9
	8 424835 001070

## Rascador yeso

### Drywall scraper





Rascador gesso

**Cuerpo de acero carbono - Juntas con soldadura TIG**  
**Mango ergonómico**

Carbon steel body - TIG welding joints  
Ergonomic handle

Corpo de aço carbono - Juntas com soldadura TIG  
Cabo ergonómico



	<b>WK600550</b> 10 / 001-008.800
	450 MM
	90 MM
	9
	8 424835 002589

## Talocha rectangular

### Rectangular trowel





Talocha rectangular

**Cuerpo de ABS**  
**Mango de madera**

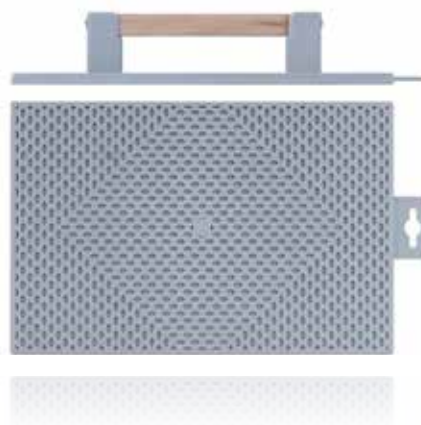
ABS body  
Wooden handle

Corpo de ABS  
Cabo de madeira



	<b>WK600250</b> 12 / 006-002.000
	270 MM
	180 MM
	10 MM
	8 424835 003579

## Talocha rectangular

### Rectangular trowel

Talocha rectangular

**Cuerpo de poliestireno**  
**Acolchado de esponja**  
**Agarre ergonómico antideslizante**

Polystyrene body  
Sponge padding  
Ergonomic non-slip grip

Corpo de poliestireno  
Acolchado de esponja  
Agarramento ergonômico antiderrapante



⊙ 	<b>WK601870</b> 12 / 001-003.200
↕	280 MM
↔	140 MM
∨ ∧	30 MM
	8 424835 007874

## Talocha rectangular

### Rectangular trowel

Talocha rectangular

**Cuerpo de poliestireno**  
**Acolchado de caucho-espuma**  
**Agarre ergonómico antideslizante**

Polystyrene body  
Rubber-foam padding  
Ergonomic non-slip grip

Corpo de poliestireno  
Acolchado de borracha-espuma  
Agarramento ergonômico antiderrapante



⊙ 	<b>WK601880</b> 12 / 001-005.000
↕	280 MM
↔	140 MM
∨ ∧	20 MM
	8 424835 007881

## Talocha rectangular

### Rectangular trowel

Talocha rectangular

**Cuerpo de aluminio**  
**Mango de madera**  
**Acolchado de EVA-goma**  
**Agarre ergonómico antideslizante**

Aluminium body  
Wood handle  
EVA-rubber padding  
Ergonomic non-slip grip

Corpo de alumínio  
Cabo de madeira  
Acolchado de EVA-borracha  
Agarramento ergonômico antiderrapante



⊙ 	<b>WK601890</b> 12 / 001-003.900
↕	240 MM
↔	100 MM
∨ ∧	20 MM
	8 424835 007898

## Lijadora rectangular paredes

### Rectangular wall sander

Lixadora rectangular paredes

**Cuerpo de ABS**

**Acolchado de EVA**

**Agarre ergonómico**

**Fijación con clip de ajuste**

ABS body

EVA padding

Ergonomic grip

Adjustment clip fixing

Corpo de ABS

Acolchado de EVA

Agarramento ergonômico

Fixação com clipe de ajuste



	<b>WK600110</b> 12 / 006-002.500
	210 MM
	105 MM
	4 MM
	8 424835 001193

## Lijadora rectangular paredes

### Rectangular wall sander

Lixadora rectangular paredes

**Cuerpo de ABS**

**Acolchado de EVA**

**Agarre ergonómico**

**Fijación con clip de ajuste**

ABS body

EVA padding

Ergonomic grip

Adjustment clip fixing

Corpo de ABS

Acolchado de EVA

Agarramento ergonômico

Fixação com clipe de ajuste



	<b>WK600120</b> 12 / 006-002.800
	230 MM
	105 MM
	6 MM
	8 424835 001087

## Lijadora rectangular paredes-techos

### Rectangular wall-ceiling sander

Lixadora rectangular paredes-tetos

**Cuerpo de ABS**

**Acolchado de EVA**

**Cabezal orientable con rosca para mango**

**Fijación con clip de ajuste**

ABS body

EVA padding

Adjustable head with handle thread

Adjustment clip fixing





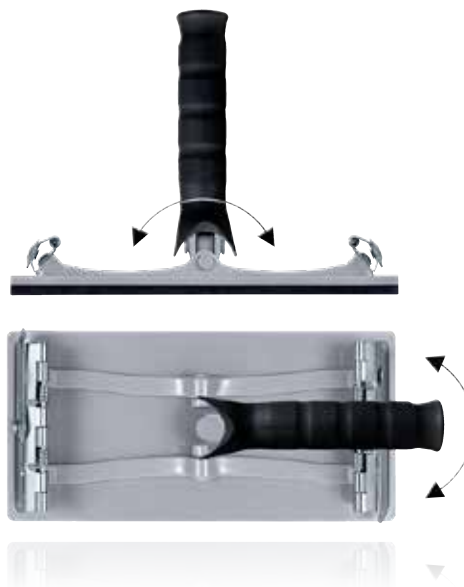

Corpo de ABS

Acolchado de EVA

Cabeça ajustável com rosca para cabo

Fixação com clipe de ajuste



	<b>WK600130</b>
	12 / 006-003.200
	210 MM
	105 MM
	6 MM
	180°
	8 424835 000875

## Lijadora circular paredes-techos

### Circular wall-ceiling sander

Lixadora circular paredes-tetos

**Cuerpo de ABS**

**Cabezal orientable con rosca para mango**

**Fijación con velcro**

**Incluye 3 discos de lijado**

ABS body

Adjustable head with handle thread

Velcro fixation

Includes 3 sanding disc





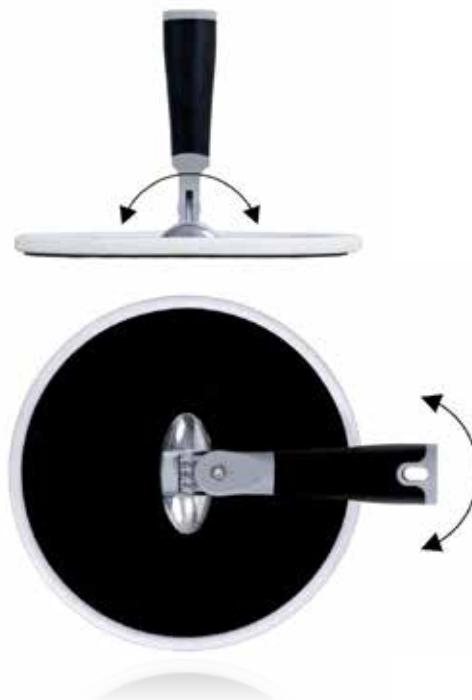

Corpo de ABS

Cabeça ajustável com rosca para cabo

Fixação com velcro

Inclui 3 discos de lixado



	<b>WK601760</b>
	20 / 001-007.900
	225 MM
	8 MM
	180°
	8 424835 007386

## Cepillo alambre

### Wire brush

Escova arame

**Cuerpo de ABS**

**Púas de acero inoxidable**

**Agarre ergonómico antideslizante**

ABS body

Stainless-steel spikes

Ergonomic non-slip grip

Corpo de ABS

Púas de aço inoxidável

Agarramento ergonômico antiderrapante



⊙ 	<b>WK600050</b> 12 / 006-001.000
↑ ↓	165 MM
■	39
↓ ↓ ↓	20 MM
	8 424835 002565

## Cepillo alambre

### Wire brush

Escova arame

**Cuerpo de ABS**

**Púas de acero carbono**

**Agarre ergonómico antideslizante**

ABS body

Carbon steel spikes

Ergonomic non-slip grip

Corpo de ABS

Púas de aço carbono

Agarramento ergonômico antiderrapante



⊙ 	<b>WK600060</b> 6 / 006-001.800	<b>WK600070</b> 6 / 006-002.200
↑ ↓	220 MM	280 MM
■	48	72
↓ ↓ ↓	30 MM	30 MM
	8 424835 002701	8 424835 002619

## Cepillo alambre

### Wire brush

Escova arame

**Cuerpo de ABS**

**Púas de acero carbono**

**Agarre ergonómico antideslizante**

ABS body

Carbon steel spikes

Ergonomic non-slip grip

Corpo de ABS

Púas de aço carbono

Agarramento ergonômico antiderrapante



⊙ 	<b>WK600090</b> 6 / 006-002.500	<b>WK600100</b> 6 / 006-003.000
↑ ↓	340 MM	340 MM
■	76	114
↓ ↓ ↓	25 MM	25 MM
	8 424835 003494	8 424835 003500

## Cepillo alambre

### Wire brush

Escova arame

**Cuerpo de ABS**

**Púas de acero carbono**

**Agarre ergonómico antideslizante**

ABS body

Carbon steel spikes

Ergonomic non-slip grip

Corpo de ABS

Púas de aço carbono

Agarramento ergonômico antiderrapante



	<b>WK600030</b> 6 / 006-002.900
	210 MM
	96
	30 MM
	8 424835 002169

## Escoba alambre

### Wire broom

Vassoura arame

**Agarre ergonómico antideslizante**

**Cabezal con rosca para mango**

**Púas de acero carbono**

Ergonomic non-slip grip

Head with handle thread

Carbon steel spikes

Agarramento ergonômico antiderrapante

Cabeça com rosca para cabo

Púas de aço carbono



	<b>WK600040</b> 6 / 006-002.900
	180 MM
	65 MM
	114
	35 MM
	8 424835 002152



## Sierra yeso

### Drywall saw

Serra gesso

**Hoja de acero inoxidable**

**Mango de ABS**

**Agarre ergonómico antideslizante**

**Incluye funda**

Stainless-steel blade

ABS handle

Ergonomic non-slip grip

Includes holster

Folha de aço inoxidável

Cabo de ABS

Agarramento ergonômico antiderrapante

Inclui bainha



○ I	<b>WK601770</b> 10 / 001-003.900
↑ ↓	160 MM
← →	10-22 MM
∨ ∧	1.5 MM
∩ ∪	38
	8 424835 007393

## Sierra yeso plegable

### Foldable drywall saw

Serra gesso dobrável

**Hoja de acero inoxidable**

**Mango de ABS**

**Agarre ergonómico antideslizante**

**Plegable en 3 posiciones**

Stainless-steel blade

ABS handle

Ergonomic non-slip grip

Foldable in 3 positions

Folha de aço inoxidável

Cabo de ABS

Agarramento ergonômico antiderrapante

Dobrável em 3 posições



○ I	<b>WK601780</b> 10 / 001-005.900
↑ ↓	130 MM
← →	10-22 MM
∨ ∧	1.2 MM
∩ ∪	35
	8 424835 007409

## Serrucho yeso

### Drywall saw

Serra gesso

**Hoja de acero carbono**

**Mango de ABS**

**Agarre ergonómico antideslizante**

Carbon steel blade

ABS handle

Ergonomic non-slip grip

Folha de aço carbono

Cabo de ABS

Agarramento ergonômico antiderrapante



⊙ 	<b>WK601980</b> 12 / 001-004.800
↑ ↓	500 MM
← →	40-120 MM
∞	1 MM
∟	140 / 7x"
	8 424835 008550

## Hacha-martillo yeso

### Drywall axe-hammer

Machado-martelo gesso

**Cabezal de acero carbono forjado**

**Cabezal tratado térmicamente para durezas extremas**

**Mango de fibra**

**Agarre ergonómico antideslizante**

**Cabezal con 2 funciones**

Forged carbon steel head

Heat treated head for extreme hardnesses

Fiber handle

Ergonomic non-slip grip

2 function head

Cabeça de aço carbono forjado

Cabeça tratada termicamente para durezas extremas

Cabo de fibra

Agarramento ergonômico antiderrapante

Cabeçal com 2 funções



⊙ 	<b>WK601710</b> 10 / 001-004.800
↑ ↓	300 MM
⏚	600 GR
∅	175 X 28 X 25 MM
	8 424835 007942

## Bolígrafo destornillador

### Screwdriver pen

Caneta chave fenda

**Cuerpo de ABS**

**Puntas de atornillado de CV**

**Puntas de atornillado magnéticas**

**Incluye 2 puntas de atornillado**

ABS body

CV screwdriver bits

Magnetic screw bits

Includes 2 screw bits





Corpo de ABS

Pontas de aparafusado de CV

Pontas de aparafusado magnéticas

Inclui 2 pontas de aparafusado



	<b>WK602000</b> 96 / 012-001.400
	135 MM
	HEX-6
	PH0-1 / 3-4 MM
	8 424835 008574

## Remachadora tacos metálicos expansión

### Metallic expansion stud riveter

Remachadora tacos metálicos expansão

**Cuerpo de acero carbono**

**Mango de caucho**

**Agarre ergonómico antideslizante**

Carbon steel body

Rubber handle





Ergonomic non-slip grip

Corpo de aço carbono

Cabo de borracha

Agarramento ergonômico antiderrapante



	<b>WK602370</b> 40 / 001-006.800
	170 MM
	M-4 / M-5 / M-6
	8 424835 009717

## Punta tope profundidad

### Depth limit bit

Ponta tope profundidade

**Punta de CV**

**Punta magnética**





CV bit

Magnetic bit

Ponta de CV

Ponta magnética



	<b>WK601930</b> 12 / 012-001.800
	HEX-6
	PH2
PCS	6
	8 424835 008239

## Portapuntas ajuste profundidad

### Depth adjust bit holder

Portapuntas ajuste profundidade

**Punta de CV**

**Punta magnética**

**Incluye punta de atornillado**

CV bit

Magnetic bit





Includes screw bit

Ponta de CV

Ponta magnética

Inlcui ponta de aparafusado



	<b>WK601940</b> 12 / 001-003.600
	HEX-6
	PH2
	8 424835 008246

## Cizalla corta chapa

### Sheet cut shear

Cizalha corta chapa

**Cuerpo de acero carbono**

**Mango de caucho**

**Agarre ergonómico antideslizante**

**Incluye cabezal rompe-recoge virutas**

**Incluye sistema de cierre**

Carbon steel body

Rubber handle

Ergonomic non-slip grip

Includes chip breaker-collector

Includes closing system

Corpo de aço carbono





Cabo de borracha

Agarramento ergonômico antiderrapante

Inclui cabeça quebra-junta rebarbas

Inclui sistema de fecho



	<b>WK602380</b> 24 / 001-006.400
	260 MM
	≤ 1.2 MM
	8 424835 009724

## Tijera corta chapa

### Sheet cut snip

Tesoura corta chapa

**Cuerpo de CV**

**Mango de caucho**

**Agarre ergonómico antideslizante**

**Incluye sistema de cierre**

CV body

Rubber handle

Ergonomic non-slip grip

Includes closing system





Corpo de CV

Cabo de borracha

Agarramento ergonômico antiderrapante

Inclui sistema de fecho



	<b>WK601950</b> 36 / 001-004.400
	250 MM
	≤ 1.2 MM
	8 424835 008253

## Punzonadora perfiles

### Profile stud crimper

Punçonadora perfis

**Cuerpo de acero carbono**

**Mango de caucho**

**Agarre ergonómico antideslizante**

Carbon steel body

Rubber handle





Ergonomic non-slip grip

Corpo de aço carbono

Cabo de borracha

Agarramento ergonômico antiderrapante



	<b>WK601960</b>
	24 / 001-014.000
	340 MM
	0.5-0.8 MM
	8 424835 008369

## Punzonadora perfiles

### Profile stud crimper

Punçonadora perfis

**Cuerpo de acero carbono**

**Mango de caucho**

**Agarre ergonómico antideslizante**

**Incluye sistema de cierre**

Carbon steel body

Rubber handle

Ergonomic non-slip grip

Includes closing system





Corpo de aço carbono

Cabo de borracha

Agarramento ergonômico antiderrapante

Inclui sistema de fecho



	<b>WK601970</b>
	24 / 001-013.500
	260 MM
	0.5-0.8 MM
	8 424835 008376

## Sierra corona

### Hole saw

Serra craneana

**Compatible con madera, yeso y plástico**

**Incluye 12 sierras corona de acero carbono**

**Incluye 2 conectores**

**Incluye broca piloto**

**Incluye maletín de transporte**

Compatible with wood, plaster and plastic

Includes 12 carbon steel hole saws

Includes 2 connectors

Includes pilot drill-bit

Includes transportation case

Compatível com madeira, gesso e plástico





Inclui 12 serras craneanas de aço carbono

Inclui 2 conectores

Inclui broca piloto

Inclui mala de transporte



	<b>WK602060</b> 12 / 001-007.800
	HEX-6 / HEX-8
	19-127 MM
	≤ 26 MM
	8 424835 008970

## Broca sierra corona HSS

### HSS hole saw drill-bit

Broca serra craneana HSS

**Compatible con metal, acero inoxidable y aluminio**

**Incluye 5 sierras corona de HSS con brocas piloto**





Compatible with metal, stainless-steel and aluminium

Includes 5 HSS hole saws with pilot drill-bits

Compatível com metal, aço inoxidável e alumínio

Inclui 5 serras craneanas de HSS com brocas piloto



	<b>WK602120</b> 12 / 001-009.200
	HEX-6-7-8
	16-30 MM
	≤ 8 MM
	8 424835 008994

## Cortador circular ajustable

### Adjustable circular cutter

#### Cortador circular ajustável

**Compatible con madera, yeso y plástico**

**Incluye juego de cuchillas de corte de acero carbono**

**Incluye colector de polvo**

**Incluye broca piloto**

Compatible with wood, plaster and plastic

Includes set of carbon steel cutting blades

Includes dust collector

Includes pilot drill-bit





Compatível com madeira, gesso e plástico

Inclui jogo de lâminas de corte de aço carbono

Inclui colector de pó

Inclui broca piloto



	<b>WK602130</b> 8 / 001-007.800
	HEX-8
	50-180 MM
	≤ 21 MM
	8 424835 009007

## Cortador circular ajustable

### Adjustable circular cutter

#### Cortador circular ajustável

**Compatible con madera, yeso y plástico**

**Incluye 2 juegos de cuchillas de corte de HSS y acero tungsteno**

**Incluye colector de polvo y 2 brocas piloto**

**Incluye 5 brocas para hormigón y 5 brocas para madera**

**Incluye lápiz y flexómetro de 2 metros**

**Incluye maletín de transporte**

Compatible with wood, plaster and plastic

Includes 2 sets of HSS and tungsten steel cutting blades

Includes dust collector and 2 pilot drill-bits

Includes 5 concrete drill-bits and 5 wood drill-bits

Includes pencil and 2-meter tape measure

Includes transportation case

Compatível com madeira, gesso e plástico

Inclui 2 jogos de lâminas de corte de HSS e aço tungstênio





Inclui colector de pó e 2 brocas piloto

Inclui 5 brocas para concreto e 5 brocas para madeira

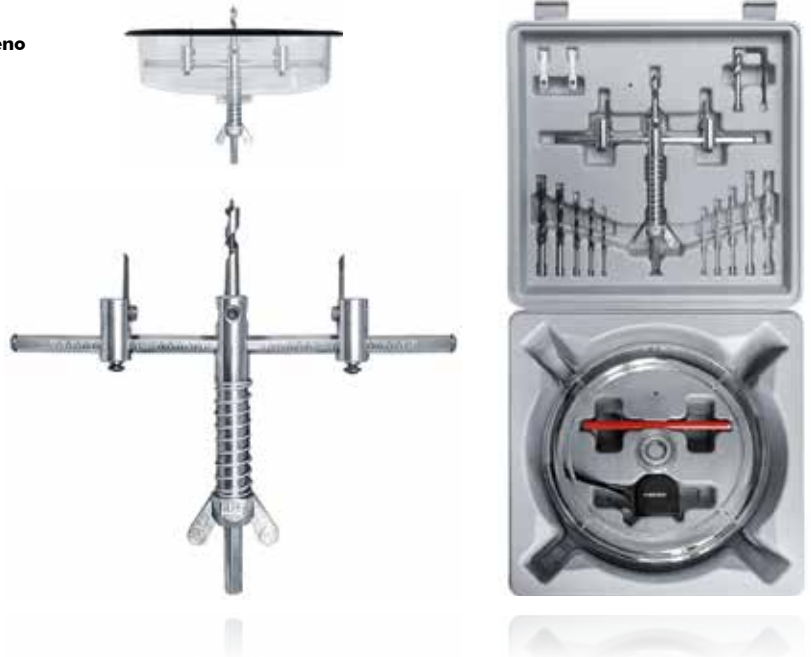
Inclui lápis e flexômetro 2 metros

Inclui mala de transporte



	<b>WK602070</b> 10 / 001-039.200
	HEX-10
	30-200 MM
	≤ 30 MM
	8 424835 008987



# Gavetilla yeso

## Mud pan

Gavetilha gesso

**Cuerpo de acero inoxidable**

**Agarre ergonómico antideslizante**

**Juntas reforzadas con soldadura TIG**

Stainless-steel body

Ergonomic non-slip grip





Reinforced TIG welding joints

Corpo de aço inoxidável

Agarramento ergonômico antiderrapante

Juntas reforçadas com soldadura TIG



	<b>WK602350</b> 12 / 001-006.000
	360 X 110 X 90 MM
	0.7 MM
	2 L
	8 424835 009687

# Dispensador-aplicador yeso

## Drywall dispenser-applicator

Dispensador-aplicador gesso

**Cuerpo de aluminio**

**Agarre ergonómico antideslizante**

**Cabezal orientable**

**Regulador de fluido**

**Extensible**

Aluminium body

Ergonomic non-slip grip

Adjustable head

Fluid regulator

Extendable

Corpo de alumínio





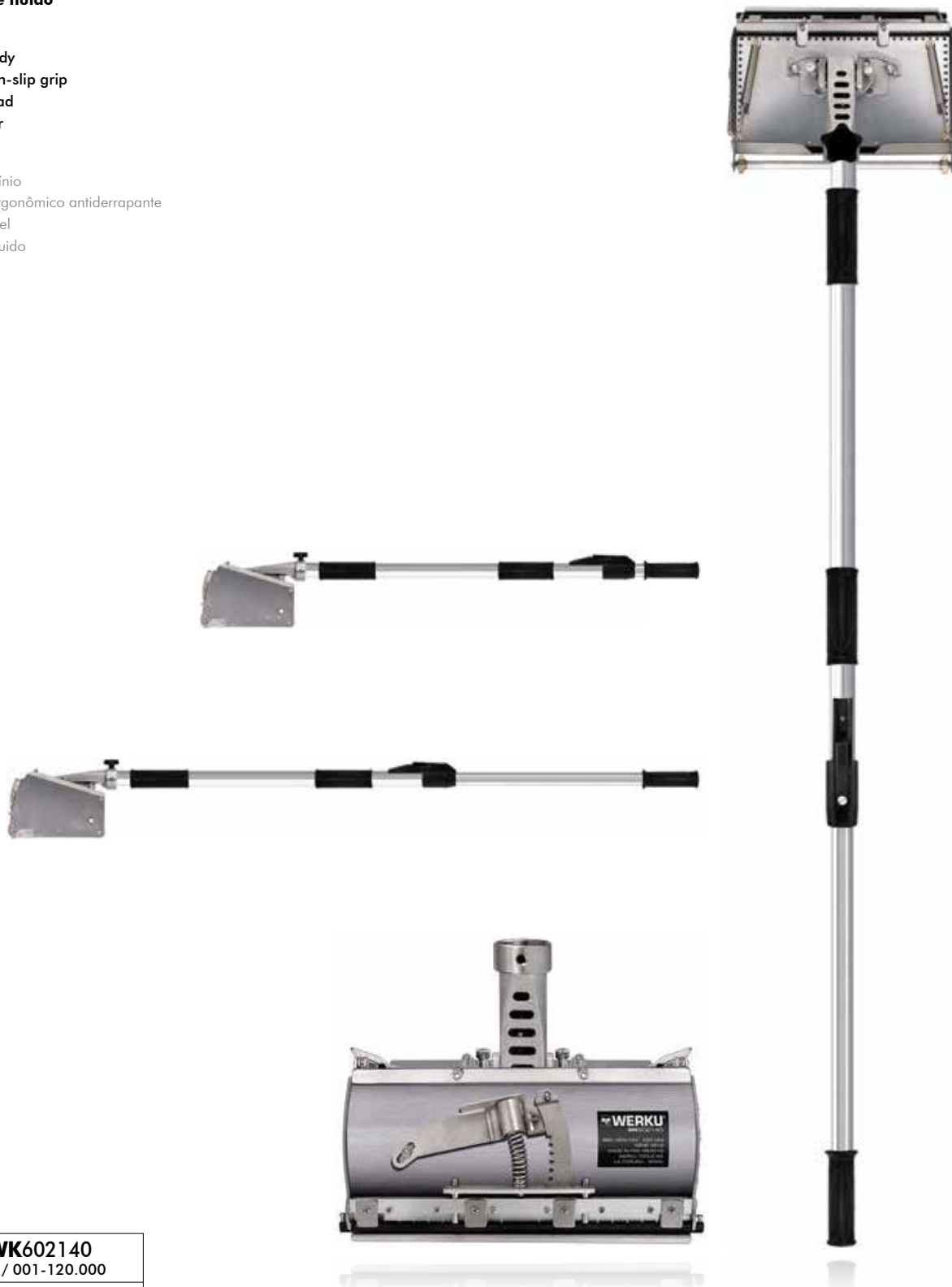

Agarramento ergonômico antiderrapante

Cabeça ajustável

Regulador de fluido

Extensível



	<b>WK602140</b> 1 / 001-120.000
	980-1600 MM
	250 MM
	2 L
	90° / 360°
	8 424835 009069

## Mordaza rápida

### Quick clamp

### Grampo rápido

Cuerpo de ABS

Barra de acero templado

Agarre ergonómico antideslizante

Soporte antideslizante

Almohadillas de protección

Liberación rápida

Función reversible

ABS body

Tempered steel bar

Ergonomic non-slip grip

Anti-slip support

Protection pads

Quick release

Reversible function

Corpo de ABS

Barra de aço temperado

Agarramento ergonômico antiderrapante

Suporte antiderrapagem

Almofadas de proteção

Liberação rápida

Função reversível



Ø	WK601900 12 / 001-007.200	WK601910 12 / 001-008.200	WK601920 12 / 001-009.200
↑↓	150 MM	300 MM	450 MM
	150 KG (daN)	150 KG (daN)	150 KG (daN)
	5.8 X 3.3 MM	5.8 X 3.3 MM	5.8 X 3.3 MM
	8 424835 008130	8 424835 008147	8 424835 008154

## Soporte extensible

### Extendable support

Suporte extensível

**Cuerpo de aluminio**

**Agarre ergonómico antideslizante**

**Soporte antideslizante**

**Cabezal orientable**

**Liberación rápida**

**Extensible**

Aluminium body

Ergonomic non-slip grip

Anti-slip support

Adjustable head

Quick release

Extendable

Corpo de alumínio

Agarramento ergonômico antiderrapante







Suporte antiderrapagem

Cabeça ajustável

Liberação rápida

Extensível



	<b>WK601720</b> 10 / 001-013.800
	1150-2900 MM
	30 KG
	128 X 77 MM
	0-45°
	8 424835 008123

## Carro-plataforma porta paneles-placas

### Panel-board carrier trolley-platform

Carro-plataforma porta painéis-placas

**Cuerpo de acero carbono**

**Ruedas castor de caucho de 120 mm**

**Ruedas traseras orientables en 360 grados**

**Fácilmente desmontable**

Carbon steel body

Rubber castor wheels of 120 mm

Adjustable rear wheels in 360 degrees

Easy to disassemble







Corpo de aço carbono

Rodas castor de borracha de 120 mm

Rodas traseiras ajustáveis em 360 graus

Facilmente desmontable



	<b>WK602360</b> 1 / 001-122.800
	900 KG
	4880 X 1220 MM
	1060 X 320 MM
	1230 MM
	8 424835 009700

## Porta paneles-placas

### Panel-board carrier

Porta painéis-placas

**Cuerpo de ABS**

**Agarre ergonómico antideslizante**

**Mango angular protector de nudillos**

ABS body

Ergonomic non-slip grip







Knuckle protector angular handle

Corpo de ABS

Agarramento ergonômico antiderrapante

Cabo angular protetor nudillos



	<b>WK602470</b> 24 / 001-004.200
	80 KG
	4880 X 1220 MM
	165 MM
	370 MM
	8 424835 010027

## Soporte paneles-placas

### Panel-board holder

Suporte painéis-placas

**Cuerpo de acero carbono**

**Altura de apoyo regulable**





Carbon steel body

Adjustable support height

Corpo de aço carbono

Apoio de altura ajustável



	<b>WK602500</b> 4 / 001-016.500
	80 KG
	4880 X 1220 MM
	810 MM
	8 424835 010058

## Elevador paneles

### Panel lifter

Elevador painéis

**Cuerpo de acero carbono**

**Ruedas castor de caucho de 120 mm**

**Ruedas orientables en 360 grados**

**Elevación horizontal y vertical**

Carbon steel body

Rubber castor wheels of 120 mm

Adjustable wheels in 360 degrees

Horizontal and vertical lifting







Corpo de aço carbono

Rodas castor de borracha de 120 mm

Rodas ajustáveis em 360 graus

Elevação horizontal e vertical



	<b>WK602150</b> 1 / 001-162.800
	68 KG
	4880 X 1220 MM
	1220-3350 MM
	0-30°
	CE
	8 424835 009076

## Elevador paneles

### Panel lifter

Elevador painéis

**Cuerpo de acero carbono**

**Plataforma de madera**

**Ruedas castor de caucho de 120 mm**

**Ruedas orientables en 360 grados**

**Elevación horizontal y vertical**

**Incluye barra de extensión adicional**

Carbon steel body

Wooden platform

Rubber castor wheels of 120 mm

Adjustable wheels in 360 degrees

Horizontal and vertical lifting

Includes additional extension bar

Corpo de aço carbono

Plataforma de madeira







Rodas castor de borracha de 120 mm

Rodas ajustáveis em 360°

Elevação horizontal e vertical

Inclui barra de extensão adicional



	<b>WK602160</b> 1 / 001-359.000
	75 KG
	4880 X 1220 MM
	1450-3500/4000 MM
	0-30°
	CE
	8 424835 009083



# Carro-plataforma portacargas

## Load carrier trolley-platform

Carro-plataforma porta-cargas

**Cuerpo de acero carbono**

**Asa de transporte acolchada de caucho**

**Plataforma de PU**

**Ruedas castor de PU de 125 mm**

**Ruedas traseras orientables en 360 grados**

**Agarre ergonómico antideslizante**

**Protección lateral contra impactos**

**Plegable**

Carbon steel body

Rubber padded carrying handle

PU platform

PU castor wheels of 125 mm

Adjustable rear wheels in 360 degrees

Ergonomic non-slip grip

Side impact protection

Foldable

Corpo de aço carbono

Alça de transporte acolchoada de borracha

Plataforma de PU

Rodas castor de PU de 125 mm





Rodas traseiras ajustáveis em 360 graus

Agarramento ergonômico antiderrapante

Proteção lateral contra impactos

Dobrável



	<b>WK602320</b> 1 / 001-042.500
	300 KG
	910 X 610 MM
	890 MM
	8 424835 009595

## Carro portacargas

### Load carrier trolley

Carro porta-cargas

**Cuerpo de acero carbono**

**Ruedas neumáticas de PU de 260 mm**

**Agarre ergonómico antideslizante**

Carbon steel body

Pneumatic PU wheels of 260 mm







Ergonomic non-slip grip

Corpo de aço carbono

Rodas pneumáticas de PU de 260 mm

Agarramento ergonômico antiderrapante



	<b>WK602310</b> 1 / 001-039.200
	200 KG
	350 X 185 MM
	1165 MM
	TÜV GS
	8 424835 009601

## Rasqueta pintura

### Paint scraper

Raspadeira pintura

#### Cuerpo de ABS

Agarre ergonómico antideslizante

Incluye hoja de corte

ABS body

Ergonomic non-slip grip

Includes cutting blade

Corpo de ABS

Agarramento ergonómico antiderrapante

Inclui lâmina de corte



	<b>WK600500</b> 10 / 010-001.200
	120 MM
	40 X 19 MM
	0.4 MM
	8 424835 002190

## Rasqueta pintura

### Paint scraper

Raspadeira pintura

#### Cuerpo de ABS

Agarre ergonómico antideslizante

Incluye hoja de corte

ABS body

Ergonomic non-slip grip

Includes cutting blade

Corpo de ABS

Agarramento ergonómico antiderrapante

Inclui lâmina de corte



	<b>WK600510</b> 10 / 005-001.800
	160 MM
	90 X 18 MM
	0.5 MM
	8 424835 002183

## Rasqueta pintura

### Paint scraper

Raspadeira pintura

#### Cuerpo de aluminio

Mango de ABS

Agarre ergonómico antideslizante

Tope de golpe metálico

Incluye hoja de corte

Aluminium body

ABS handle

Ergonomic non-slip grip

Metallic hit end

Includes cutting blade

Corpo de alumínio

Cabo de ABS

Agarramento ergonómico antiderrapante

Tope de golpe metálico

Inclui lâmina de corte



	<b>WK600520</b> 5 / 001-003.400
	300 MM
	100 X 18 MM
	0.6 MM
	8 424835 002336

## Rasqueta pintura

### Paint scraper

Raspadeira pintura

#### Cuerpo de aluminio

Mango de ABS

Agarre ergonómico antideslizante

Tope de golpe metálico

Incluye hoja de corte

Aluminium body

ABS handle

Ergonomic non-slip grip

Metallic hit end

Includes cutting blade

Corpo de alumínio

Cabo de ABS

Agarramento ergonómico antiderrapante

Tope de golpe metálico

Inclui lâmina de corte



	<b>WK600530</b> 5 / 001-005.400
	600 MM
	100 X 18 MM
	0.6 MM
	8 424835 001919

## Rasqueta pintura

### Paint scraper

Raspadeira pintura

**Cuerpo de acero forjado**

**Mango de ABS**

**Agarre ergonómico**

**Incluye hoja de corte**

Forged steel body

ABS handle

Ergonomic grip

Includes cutting blade

Corpo de aço forjado

Cabo de ABS

Agarramento ergonômico

Inclui lâmina de corte



	<b>WK600470</b> 6 / 001-004.800
	240 MM
	25 X 25 X 25 MM
	2.0 MM
	8 424835 004651

## Rasqueta pintura

### Paint scraper

Raspadeira pintura

**Cuerpo de acero forjado**

**Mango de ABS**

**Agarre ergonómico**

**Incluye hoja de corte**

Forged steel body

ABS handle

Ergonomic grip

Includes cutting blade

Corpo de aço forjado

Cabo de ABS

Agarramento ergonômico

Inclui lâmina de corte



	<b>WK600480</b> 6 / 001-005.800
	250 MM
	52 X 8 MM
	2.0 MM
	8 424835 004644

## Rasqueta pintura

### Paint scraper

Raspadeira pintura

**Cuerpo de acero forjado**

**Mango de ABS**

**Mango auxiliar**

**Agarre ergonómico**

**Incluye hoja de corte**

Forged steel body

ABS handle

Auxiliary handle

Ergonomic grip

Includes cutting blade

Corpo de aço forjado

Cabo de ABS

Cabo auxiliar

Agarramento ergonômico

Inclui lâmina de corte



	<b>WK600490</b> 6 / 001-006.800
	290 MM
	65 X 8 MM
	2.0 MM
	8 424835 001384

## Cepillo bordes paneles-placas yeso

### Drywall panel-board edge plane

Plaina bordas painéis-placas gesso

**Cuerpo de ABS**

**Agarre ergonómico**

**Incluye 2 hojas de corte**

ABS body

Ergonomic grip

Includes 2 cutting blades

Corpo de ABS

Agarramento ergonômico

Inclui 2 lâminas de corte



	<b>WK602480</b> 60 / 001-004.000
	240 MM
	23 X 23 / 53 X 19 MM
	9.5-15 MM
	22.5° / 45°
	8 424835 010034

## Cortador horizontal-circular paneles-placas yeso

### Drywall panel-board horizontal-circular cutter

Cortador horizontal-circular painéis-placas gesso

**Cuerpo de acero y ABS**

**Agarre ergonómico**

**Medición en centímetros**

**Incluye disco de corte**

Steel and ABS body

Ergonomic grip

Centimeter measurement

Includes cutting disc

Corpo de aço e ABS

Agarramento ergonômico

Medição em centímetros

Inclui disco de corte



	<b>WK602490</b> 12 / 001-014.200
	700 MM
	600 MM
	1200 MM
	10 MM
	8 424835 010041

## Cutter

## Cutter

### Cutter

#### Cuerpo de ABS

Agarre ergonómico antideslizante

Incluye 4 hojas de corte

ABS body

Ergonomic non-slip grip

Includes 4 cutting blades

Corpo de ABS

Agarramento ergonómico antiderrapante

Inclui 4 lâminas de corte



	<b>WK600620</b> 12 / 012-001.200
	135 MM
	80 X 9 MM
	0.5 MM
	8 424835 004156

## Cutter

## Cutter

### Cutter

#### Cuerpo de ABS

Agarre ergonómico antideslizante

Incluye 4 hojas de corte

ABS body

Ergonomic non-slip grip

Includes 4 cutting blades

Corpo de ABS

Agarramento ergonómico antiderrapante

Inclui 4 lâminas de corte



	<b>WK600630</b> 12 / 006-002.400
	155 MM
	100 X 18 MM
	0.5 MM
	8 424835 004286

## Cutter

## Cutter

### Cutter

#### Cuerpo de aluminio

Agarre ergonómico antideslizante

Incluye hoja de corte

Aluminium body

Ergonomic non-slip grip

Includes cutting blade

Corpo de alumínio

Agarramento ergonómico antiderrapante

Inclui lâmina de corte



	<b>WK600640</b> 12 / 006-002.400
	155 MM
	60 X 19 MM
	0.5 MM
	8 424835 002237

## Hoja rasqueta Scraper blade Lâmina raspadeira

**Cuerpo de acero carbono**  
**Triple filo**

Carbon steel body  
Triple-edged

Corpo de aço carbono  
Triplo gume



	<b>WK300010</b> 6 / 001-002.200
	25 X 25 X 25 MM
	2.0 MM
	8 424835 002879

## Hoja rasqueta Scraper blade Lâmina raspadeira

**Cuerpo de acero carbono**  
**Doble filo**

Carbon steel body  
Double-edged

Corpo de aço carbono  
Duplo gume



	<b>WK300020</b> 6 / 001-002.800
	52 X 8 MM
	2.0 MM
	8 424835 002886

## Hoja rasqueta Scraper blade Lâmina raspadeira

**Cuerpo de acero carbono**  
**Doble filo**

Carbon steel body  
Double-edged

Corpo de aço carbono  
Duplo gume



	<b>WK300030</b> 6 / 001-003.200
	65 X 8 MM
	2.0 MM
	8 424835 002893

## Hoja rasqueta Scraper blade Lâmina raspadeira

**Cuerpo de acero carbono**  
**Un solo filo**

Carbon steel body  
Single-edged

Corpo de aço carbono  
Um só gume



	<b>WK300040</b> 6 / 006-000.900
	40 X 19 MM
	0.4 MM
PCS	5
	8 424835 002909

## Hoja cutter/rasqueta Cutter/scrapper blade Lâmina cutter/raspadeira





**Cuerpo de acero carbono**  
**Un solo filo con 8 segmentos**

Carbon steel body  
Single-edged with 8 segments

Corpo de aço carbono  
Um só gume com 8 segmentos

  
**WK600630**  
**WK600520**  
**WK600530**



 1	<b>WK300100</b> 6 / 006-000.700
	100 X 18 MM
	0.5 MM
PCS	10
	8 424835 003593

## Hoja cutter Cutter blade Lâmina cutter





**Cuerpo de acero carbono**  
**Un solo filo con 13 segmentos**

Carbon steel body  
Single-edged with 13 segments

Corpo de aço carbono  
Um só gume com 13 segmentos

  
**WK600620**



 1	<b>WK300090</b> 6 / 006-000.500
	80 X 9 MM
	0.5 MM
PCS	10
	8 424835 003128

## Hoja cutter Cutter blade Lâmina cutter





**Cuerpo de acero carbono**  
**Un solo filo**

Carbon steel body  
Single-edged

Corpo de aço carbono  
Um só gume

  
**WK600640**



 1	<b>WK300110</b> 6 / 006-000.700
	60 X 19 MM
	0.5 MM
PCS	10
	8 424835 004514

## Hoja rasqueta Scrapper blade Lâmina raspadeira





**Cuerpo de acero carbono**  
**Doble filo**

Carbon steel body  
Double-edged

Corpo de aço carbono  
Duplo gume

  
**WK600510**



 1	<b>WK300050</b> 6 / 006-001.000
	90 X 18 MM
	0.5 MM
PCS	5
	8 424835 003272



## Tiralíneas

### Chalk line

Tira-linhas

**Cuerpo de ABS**

**Manivela plegable**

**Incluye polvo tiralíneas de 50 gramos**

ABS body

Foldable handle

Includes 50 gram chalk line powder

Corpo de ABS

Manivela dobrável

Inclui pó tira-linhas de 50 gramas



**WK600200**  
6 / 001-003.600



30 M



8 424835 003722

## Tiralíneas multiplicador

### Multiplier chalk line

Tira-linhas multiplicador

**Cuerpo de ABS**

**Manivela plegable**

**Función de enrollado rápido**

**Incluye polvo tiralíneas de 50 gramos**

ABS body

Foldable handle

Fast speed rolling function

Includes 50 gram chalk line powder

Corpo de ABS

Manivela dobrável

Função de enrolado rápido

Inclui pó tira-linhas de 50 gramas



**WK600210**  
6 / 001-004.800



30 M



8 424835 003739



**Polvo tiralíneas**  
**Chalk line powder**  
Pó tira-linhas

**Tiza ultrafina con micropartículas**  
**Color azul**

Ultrafine chalk with microparticles  
Blue color

Giz ultrafino com micropartículas  
Cor azul



	<b>WK301890</b> 10 / 005-001.200	<b>WK301900</b> 10 / 005-002.000
	250 GR	500 GR
	8 424835 004361	8 424835 001186

## Regla multifunción

### Multi-function ruler

Regra multifunção

**Cuerpo de ABS**

**Medición en centímetros**







ABS body

Centimeter measuring

Corpo de ABS

Medição em centímetros



	<b>WK600600</b> 12 / 006-001.400
	450 MM
	150 MM
	1 MM
	45-90°
	8 424835 003104

## Regla multifunción

### Multi-function ruler

Regra multifunção

**Cuerpo de ABS**

**Hoja de acero inoxidable**





ABS body

Stainless-steel blade

Corpo de ABS

Lâmina de aço inoxidável



	<b>WK600570</b> 12 / 006-002.900
	600 X 30 MM
	0.5 MM
	8 424835 002718

## Nivel rectangular

### Rectangular level

Nível retangular

#### Cuerpo de aluminio

Nivelado horizontal, vertical y ajustable 0-90°

Protección lateral contra impactos

Magnético

Medición en centímetros

Aluminium body

Horizontal, vertical and adjustable 0-90° levelling

Lateral protection against impacts

Magnetic

Centimeter measuring

Corpo de alumínio





Nivelado horizontal, vertical e ajustável 0-90°

Proteção lateral contra impactos

Magnético

Medição em centímetros



	<b>WK602170</b> 10 / 001-006.400	<b>WK602180</b> 10 / 001-007.400	<b>WK602190</b> 10 / 001-008.500
	600 MM	800 MM	1000 MM
	0.5 MM/M	0.5 MM/M	0.5 MM/M
	CLASS-I	CLASS-I	CLASS-I
	8 424835 009144	8 424835 009151	8 424835 009168

## Nivel ala avión

### Plane wing level

Nível asa avião

#### Cuerpo de aluminio

Nivelado horizontal, vertical y 45°

Protección lateral contra impactos

Medición en centímetros

Aluminium body

Horizontal, vertical and 45° levelling

Lateral protection against impacts

Centimeter measuring





Corpo de alumínio

Nivelado horizontal, vertical e 45°

Proteção lateral contra impactos

Medição em centímetros



	<b>WK602300</b> 10 / 001-011.500
	600 MM
	0.5 MM/M
	CLASS-I
	8 424835 009533

## Maza goma

### Rubber mallet

Martelo borracha

**Cabecal de goma**  
**Mango de fibra**  
**Agarre ergonómico antideslizante**

Rubber head  
 Fiber handle  
 Ergonomic non-slip grip

Cabecal de borracha  
 Cabo de fibra  
 Agarramento ergonómico antiderrapante



Ø	<b>WK601670</b>	<b>WK601680</b>	<b>WK601690</b>
1	36 / 001-003.000	24 / 001-003.600	24 / 001-004.800
↕	310 MM	340 MM	380 MM
⚖	340 GR	450 GR	680 GR
⊘	80 X 50 MM	90 X 55 MM	100 X 60 MM
	8 424835 006679	8 424835 006686	8 424835 006693

## Maceta

### Club hammer

Maceta

**Cabecal de acero carbono forjado**  
**Cabecal tratado térmicamente para durezas extremas**  
**Mango de fibra**  
**Agarre ergonómico antideslizante**  
**Unión cabezal y mango reforzada con sistema de fijación eterna de nylon**

Forged carbon steel head  
 Heat treated head for extreme hardness  
 Fiber handle  
 Ergonomic non-slip grip  
 Head and handle union reinforced with eternal nylon fixing system

Cabecal de aço carbono forjado  
 Cabecal tratada termicamente para dureza extrema  
 Cabo de fibra  
 Agarramento ergonómico antiderrapante  
 União cabeçal e cabo reforçada com sistema de fixação eterna de nylon



Ø	<b>WK601730</b>	<b>WK601740</b>	<b>WK601750</b>
1	12 / 001-005.200	12 / 001-005.900	12 / 001-006.600
↕	265 MM	265 MM	265 MM
⚖	1000 GR	1250 GR	1500 GR
⊘	94 X 40 X 40 MM	98 X 44 X 44 MM	108 X 46 X 46 MM
	8 424835 007300	8 424835 007317	8 424835 007324

# Maceta

## Club hammer

Maceta

**Cabezal de acero carbono forjado**

**Cabezal tratado térmicamente para durezas extremas**

**Mango de fibra**

**Agarre ergonómico antideslizante**

**Unión cabezal y mango reforzada con sistema de fijación eterna de nylon**

Forged carbon steel head

Heat treated head for extreme hardness

Fiber handle

Ergonomic non-slip grip

Head and handle union reinforced with eternal nylon fixing system

Cabeçal de aço carbono forjado





Cabeçal tratada termicamente para dureza extrema

Cabo de fibra

Agarramento ergonômico antiderrapante

União cabeçal e cabo reforçada com sistema de fixação eterna de nylon



	<b>WK602390</b> 6 / 001-016.000	<b>WK602400</b> 4 / 001-021.400
	910 MM	910 MM
	3 KG	5 KG
	140 X 55 X 55 MM	160 X 67 X 67 MM
	8 424835 009755	8 424835 009762

## Pistola grapadora

### Stapler gun

Pistola agrafadora

**Cuerpo de acero forjado y acero inoxidable**

**Agarre ergonómico**

**Función de regulación de fuerza de impacto**

**Función de liberación rápida de atascos**

**Clip de seguridad de palanca**

**Incluye 200 grapas**

Forged steel and stainless-steel body

Ergonomic grip

Impact power adjustment function

Quick jam release function

Lever safety clip

Includes 200 staples

Corpo de aço forjado e aço inoxidável

Agarramento ergonômico

Função de regulação de força de impacto

Função liberação rápida de atascos

Clipe de segurança de alavanca

Inclui 200 agrafos

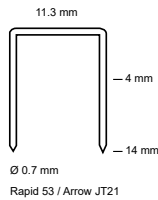

## Pistola grapadora-clavadora

### Stapler-nailer gun

Pistola agrafadora-pregadora

**Cuerpo de acero forjado y acero inoxidable**

**Agarre ergonómico**

**Función de regulación de fuerza de impacto**

**Función de liberación rápida de atascos**

**Clip de seguridad de palanca**

**Incluye 200 grapas, 200 grapas U y 200 clavos**

Forged steel and stainless-steel body

Ergonomic grip

Impact power adjustment function

Quick jam release function

Lever safety clip

Includes 200 staples, 200 U staples and 200 nails

Corpo de aço forjado e aço inoxidável

Agarramento ergonômico

Função de regulação de força de impacto

Função liberação rápida de atascos

Clipe de segurança de alavanca

Inclui 200 agrafos, 200 agrafos U e 200 pregos

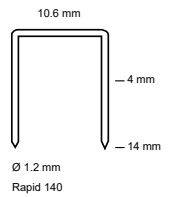
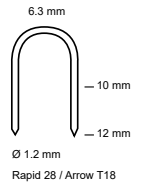
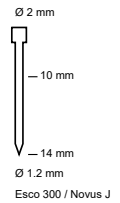

	<b>WK601790</b> 12 / 001-005.800
	0.7 MM
	11.3 MM
	4 - 14 MM
	100
	TÜV GS
	8 424835 007614

	<b>WK601800</b> 12 / 001-006.400
	1.2 MM
	10.6 MM
	4 - 14 MM
	1.2 MM
	6.3 MM
	10 - 12 MM
	1.2 MM
	10 - 14 MM
	100
	TÜV GS
	8 424835 007621

# Pistola grapadora-clavadora

## Stapler-nailer gun

Pistola agrafadora-pregadora

**Cuerpo de acero forjado y acero inoxidable**

**Agarre ergonómico antideslizante**

**Función de regulación de fuerza de impacto**

**Función de liberación rápida de atascos**

**Clip de seguridad de palanca**

**Clip de sujeción para el cinturón**

Forged steel and stainless-steel body

Ergonomic non-slip grip

Impact power adjustment function

Quick jam release function

Lever safety clip

Fastening belt clip

Corpo de aço forjado e aço inoxidável

Agarramento ergonômico antiderrapante

Função de regulação de força de impacto

Função liberação rápida de atascos

Clipe de segurança de alavanca

Clipe de sujeição para o cinto



Ø 2 mm

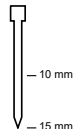

Ø 1.2 mm

Esco 300 / Novus J

6.3 mm

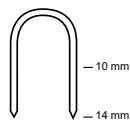

Ø 1.2 mm

Rapid 28 / Arrow T18

10.6 mm

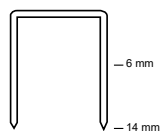

Ø 1.2 mm

Rapid 140

11.3 mm

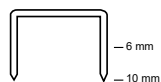

Ø 1.2 mm

Rapid 53

○ I	<b>WK601810</b> 12 / 001-012.400
□∅	1.2 MM
□↔	10.6 MM
□↑↓	6 - 14 MM
∩∅	1.2 MM
∩↔	6.3 MM
∩↑↓	10 - 14 MM
□∅	1.2 MM
□↔	11.3 MM
□↑↓	6 - 10 MM
∅	1.2 MM
↑↓	10 - 15 MM
☰	120
☰	TÜV GS
	8 424835 007638





# Herramientas neumáticas y airless

## Pneumatic and airless tools

Ferramentas pneumáticas e airless



## Pistola pintar gravedad retoques HVLP-I HVLP-I retouch gravity paint spray gun

Pistola pintar gravidade retoques HVLP-I

**Cuerpo de aluminio**  
**Acabado cromado y pulido**  
**Agarre ergonómico**  
**Regulador de abanico**  
**Regulador de fluido**  
**Regulador de presión**  
**Incluye kit de limpieza**

Aluminium body  
Polished chrome finish  
Ergonomic grip  
Pattern regulator  
Fluid regulator  
Pressure regulator  
Includes cleaning kit

Corpo de alumínio  
Acabamento cromado e polido  
Agarramento ergonómico  
Regulador de leque  
Regulador de fluido  
Regulador de pressão  
Inclui kit de limpeza



**HVLP-I (alto volumen a baja presión) reduce el consumo del producto a pulverizar un 30%, acorta el tiempo de trabajo un 20%, disminuye el consumo de aire un 15% y genera una buena calidad de pulverización y acabado.**

HVLP-I (high volume at low pressure) reduces the consumption of the product to be sprayed by 30%, shortens the working time by 20%, reduces air consumption by 15% and generates a good quality of spray and finish.

HVLP-I (alto volumen a baixa pressão) reduz o consumo do produto a ser pulverizado em 30%, reduz o tempo de trabalho em 20%, reduz o consumo de ar em 15% e gera uma boa qualidade de pulverização e acabamento.

	<b>WK500730</b> 20 / 001-011.800
	≥ 1.5 HP
	2.5 - 3.5 BAR
	8 BAR
	BSP 1/4"
	100 LPM
	0.8 MM
	125 ML
	CE
	8 424835 001711

## Pistola pintar gravedad HVLP-I HVLP-I gravity paint spray gun

Pistola pintar gravidade HVLP-I

**Cuerpo de aluminio**  
**Acabado cromado y pulido**  
**Agarre ergonómico**  
**Regulador de abanico**  
**Regulador de fluido**  
**Regulador de presión**  
**Incluye kit de limpieza**

Aluminium body  
Polished chrome finish  
Ergonomic grip  
Pattern regulator  
Fluid regulator  
Pressure regulator  
Includes cleaning kit

Corpo de alumínio  
Acabamento cromado e polido  
Agarramento ergonómico  
Regulador de leque  
Regulador de fluido  
Regulador de pressão  
Inclui kit de limpeza



**HVLP-I (alto volumen a baja presión) reduce el consumo del producto a pulverizar un 30%, acorta el tiempo de trabajo un 20%, disminuye el consumo de aire un 15% y genera una buena calidad de pulverización y acabado.**

HVLP-I (high volume at low pressure) reduces the consumption of the product to be sprayed by 30%, shortens the working time by 20%, reduces air consumption by 15% and generates a good quality of spray and finish.

HVLP-I (alto volumen a baixa pressão) reduz o consumo do produto a ser pulverizado em 30%, reduz o tempo de trabalho em 20%, reduz o consumo de ar em 15% e gera uma boa qualidade de pulverização e acabamento.

	<b>WK500740</b> 10 / 001-015.800
	≥ 1.5 HP
	3 - 4 BAR
	8 BAR
	BSP 1/4"
	175 LPM
	1.7 MM
	600 ML
	CE
	8 424835 001728

# Pistola pintar succión HVLP-I

## HVLP-I suction paint spray gun

Pistola pintar sucção HVLP-I

**Cuerpo de aluminio**  
**Acabado cromado y pulido**  
**Agarre ergonómico**  
**Regulador de abanico**  
**Regulador de fluido**  
**Regulador de presión**  
**Incluye kit de limpieza**

Aluminium body  
Polished chrome finish  
Ergonomic grip  
Pattern regulator  
Fluid regulator  
Pressure regulator  
Includes cleaning kit

Corpo de alumínio  
Acabamento cromado e polido  
Agarramento ergonômico  
Regulador de leque  
Regulador de fluido  
Regulador de pressão  
Inclui kit de limpeza



**HVLP-I (alto volumen a baja presión) reduce el consumo del producto a pulverizar un 30%, acorta el tiempo de trabajo un 20%, disminuye el consumo de aire un 15% y genera una buena calidad de pulverización y acabado.**

HVLP-I (high volume at low pressure) reduces the consumption of the product to be sprayed by 30%, shortens the working time by 20%, reduces air consumption by 15% and generates a good quality of spray and finish.

HVLP-I (alto volumen a baixa pressão) reduz o consumo do produto a ser pulverizado em 30%, reduz o tempo de trabalho em 20%, reduz o consumo de ar em 15% e gera uma boa qualidade de pulverização e acabamento.

	<b>WK500750</b> 10 / 001-017.800
	≥ 2 HP
	3 - 4 BAR
	8 BAR
	BSP 1/4"
	175 LPM
	1.7 MM
	1000 ML
	CE
	8 424835 001735

## Pistola pintar gravedad retoques HVLP-II

### HVLP-II retouch gravity paint spray gun

Pistola pintar gravidade retoques HVLP-II

**Cuerpo de aluminio**  
**Acabado cromado mate**  
**Agarre ergonómico**  
**Regulador de abanico**  
**Regulador de fluido**  
**Regulador de presión**  
**Incluye kit de limpieza**

Aluminium body  
 Matt chrome finish  
 Ergonomic grip  
 Pattern regulator  
 Fluid regulator  
 Pressure regulator  
 Includes cleaning kit

Corpo de alumínio  
 Acabamento cromado mate  
 Agarramento ergonómico  
 Regulador de leque  
 Regulador de fluido  
 Regulador de pressão  
 Inclui kit de limpeza



**HVLP-II (alto volumen a baja presión) reduce el consumo del producto a pulverizar un 40%, acorta el tiempo de trabajo un 30%, disminuye el consumo de aire un 40% y genera una buena calidad de pulverización y acabado.**

HVLP-II (high volume at low pressure) reduces the consumption of the product to be sprayed by 40%, shortens the working time by 30%, reduces air consumption by 40% and generates a good quality of spray and finish.

HVLP-II (alto volumen a baixa pressão) reduz o consumo do produto a ser pulverizado em 40%, reduz o tempo de trabalho em 30%, reduz o consumo de ar em 40% e gera uma boa qualidade de pulverização e acabamento.

	<b>WK501100</b> 30 / 001-016.800
	≥ 1.5 HP
	1 - 2.5 BAR
	8 BAR
	BSP 1/4"
	75 LPM
	0.8 MM
	125 ML
	CE
	8 424835 009410

## Pistola pintar gravedad HVLP-II

### HVLP-II gravity paint spray gun

Pistola pintar gravidade HVLP-II

**Cuerpo de aluminio**  
**Acabado cromado mate**  
**Agarre ergonómico**  
**Regulador de abanico**  
**Regulador de fluido**  
**Regulador de presión**  
**Incluye kit de limpieza**

Aluminium body  
 Matt chrome finish  
 Ergonomic grip  
 Pattern regulator  
 Fluid regulator  
 Pressure regulator  
 Includes cleaning kit

Corpo de alumínio  
 Acabamento cromado mate  
 Agarramento ergonómico  
 Regulador de leque  
 Regulador de fluido  
 Regulador de pressão  
 Inclui kit de limpeza



**HVLP-II (alto volumen a baja presión) reduce el consumo del producto a pulverizar un 40%, acorta el tiempo de trabajo un 30%, disminuye el consumo de aire un 40% y genera una buena calidad de pulverización y acabado.**

HVLP-II (high volume at low pressure) reduces the consumption of the product to be sprayed by 40%, shortens the working time by 30%, reduces air consumption by 40% and generates a good quality of spray and finish.

HVLP-II (alto volumen a baixa pressão) reduz o consumo do produto a ser pulverizado em 40%, reduz o tempo de trabalho em 30%, reduz o consumo de ar em 40% e gera uma boa qualidade de pulverização e acabamento.

	<b>WK501080</b> 10 / 001-021.800
	≥ 1.5 HP
	1.5 - 3 BAR
	8 BAR
	BSP 1/4"
	125 LPM
	1.7 MM
	600 ML
	CE
	8 424835 009397

## Pistola pintar succión HVLP-II

### HVLP-II suction paint spray gun

#### Pistola pintar sucção HVLP-II

**Cuerpo de aluminio**  
**Acabado cromado mate**  
**Agarre ergonómico**  
**Regulador de abanico**  
**Regulador de fluido**  
**Regulador de presión**  
**Incluye kit de limpieza**

Aluminium body  
Matt chrome finish  
Ergonomic grip  
Pattern regulator  
Fluid regulator  
Pressure regulator  
Includes cleaning kit

Corpo de alumínio  
Acabamento cromado mate  
Agarramento ergonômico  
Regulador de leque  
Regulador de fluido  
Regulador de pressão  
Inclui kit de limpeza



**HVLP-II (alto volumen a baja presión) reduce el consumo del producto a pulverizar un 40%, acorta el tiempo de trabajo un 30%, disminuye el consumo de aire un 40% y genera una buena calidad de pulverización y acabado.**

HVLP-II (high volume at low pressure) reduces the consumption of the product to be sprayed by 40%, shortens the working time by 30%, reduces air consumption by 40% and generates a good quality of spray and finish.

HVLP-II (alto volumen a baixa pressão) reduz o consumo do produto a ser pulverizado em 40%, reduz o tempo de trabalho em 30%, reduz o consumo de ar em 40% e gera uma boa qualidade de pulverização e acabamento.

	<b>WK501090</b> 10 / 001-023.800
	≥ 2 HP
	1.5 - 3 BAR
	8 BAR
	BSP 1/4"
	125 LPM
	1.7 MM
	1000 ML
	CE
	8 424835 009403

## Pistola pintar gravedad retoques HVLP-III

### HVLP-III retouch gravity paint spray gun

Pistola pintar gravidade retoques HVLP-III

Cuerpo de aluminio  
Acabado electroforético  
Agarre ergonómico  
Regulador de abanico  
Regulador de fluido  
Regulador de presión  
Incluye kit de limpieza  
Incluye maletín de transporte

Aluminium body  
Electrophoretic finish  
Ergonomic grip  
Pattern regulator  
Fluid regulator  
Pressure regulator  
Includes cleaning kit  
Includes transportation case

Corpo de alumínio  
Acabamento eletroforético  
Agarramento ergonômico  
Regulador de leque  
Regulador de fluido  
Regulador de pressão  
Inclui kit de limpeza  
Inclui mala de transporte



**HVLP-III (alto volumen, baja presión) reduce el consumo del producto a pulverizar un 50%, acorta el tiempo de trabajo un 40%, disminuye el consumo de aire un 50% y genera una excelente calidad de pulverización y acabado, todo ello con una baja presión de fluido.**

HVLP-III (high volume, low pressure) reduces the consumption of the product to be sprayed by 50%, shortens the working time by 40%, reduces air consumption by 50% and generates an excellent quality of spray and finish.

HVLP-III (alto volume, baixa pressão) reduz o consumo do produto a ser pulverizado em 50%, reduz o tempo de trabalho em 40%, reduz o consumo de ar em 50% e gera uma qualidade excelente de pulverização e acabamento.

	<b>WK501000</b> 5 / 001-0049.500
	≥ 1.5 HP
	1 - 2.5 BAR
	10 BAR
	BSP 1/4"
	50 LPM
	0.8 / 1.0 MM
	125 ML
	CE
	8 424835 009373

## Pistola pintar gravedad HVLP-III

### HVLP-III gravity paint spray gun

Pistola pintar gravidade HVLP-III

Cuerpo de aluminio  
Acabado electroforético  
Agarre ergonómico  
Regulador de abanico  
Regulador de fluido  
Regulador de presión  
Incluye kit de limpieza  
Incluye maletín de transporte

Aluminium body  
Electrophoretic finish  
Ergonomic grip  
Pattern regulator  
Fluid regulator  
Pressure regulator  
Includes cleaning kit  
Includes transportation case

Corpo de alumínio  
Acabamento eletroforético  
Agarramento ergonômico  
Regulador de leque  
Regulador de fluido  
Regulador de pressão  
Inclui kit de limpeza  
Inclui mala de transporte



**HVLP-III (alto volumen, baja presión) reduce el consumo del producto a pulverizar un 50%, acorta el tiempo de trabajo un 40%, disminuye el consumo de aire un 50% y genera una excelente calidad de pulverización y acabado, todo ello con una baja presión de fluido.**

HVLP-III (high volume, low pressure) reduces the consumption of the product to be sprayed by 50%, shortens the working time by 40%, reduces air consumption by 50% and generates an excellent quality of spray and finish.

HVLP-III (alto volume, baixa pressão) reduz o consumo do produto a ser pulverizado em 50%, reduz o tempo de trabalho em 40%, reduz o consumo de ar em 50% e gera uma qualidade excelente de pulverização e acabamento.

	<b>WK500470</b> 5 / 001-0059.500
	≥ 1.5 HP
	1.5 - 3 BAR
	10 BAR
	BSP 1/4"
	100 LPM
	1.3 / 1.5 MM
	600 ML
	CE
	8 424835 007966

# Pistola pintar succión HVLP-III

## HVLP-III suction paint spray gun

### Pistola pintar sucção HVLP-III

**Cuerpo de aluminio**  
**Acabado electroforético**  
**Agarre ergonómico**  
**Regulador de abanico**  
**Regulador de fluido**  
**Regulador de presión**  
**Incluye kit de limpieza**  
**Incluye maletín de transporte**

Aluminium body  
Electrophoretic finish  
Ergonomic grip  
Pattern regulator  
Fluid regulator  
Pressure regulator  
Includes cleaning kit  
Includes transportation case

Corpo de alumínio  
Acabamento eletroforético  
Agarramento ergonômico  
Regulador de leque  
Regulador de fluido  
Regulador de pressão  
Inclui kit de limpeza  
Inclui mala de transporte



**HVLP-III (alto volumen, baja presión) reduce el consumo del producto a pulverizar un 50%, acorta el tiempo de trabajo un 40%, disminuye el consumo de aire un 50% y genera una excelente calidad de pulverización y acabado, todo ello con una baja presión de fluido.**

HVLP-III (high volume, low pressure) reduces the consumption of the product to be sprayed by 50%, shortens the working time by 40%, reduces air consumption by 50% and generates an excellent quality of spray and finish.

HVLP-III (alto volume, baixa pressão) reduz o consumo do produto a ser pulverizado em 50%, reduz o tempo de trabalho em 40%, reduz o consumo de ar em 50% e gera uma qualidade excelente de pulverização e acabamento.

	<b>WK500480</b> 5 / 001-061.500
	≥ 2 HP
	1.5 - 3 BAR
	10 BAR
	BSP 1/4"
	100 LPM
	1.3 / 1.5 MM
	1000 ML
	CE
	8 424835 007973



## Pistola pintar caldera presión

### Pressure tank paint spray gun











Pistola pintar tanque pressão

**Cuerpo de aluminio**  
**Acabado cromado y pulido**  
**Agarre ergonómico**  
**Regulador de abanico**  
**Regulador de fluido**  
**Regulador de presión**

Aluminium body  
Polished chrome finish  
Ergonomic grip  
Pattern regulator  
Fluid regulator  
Pressure regulator

Corpo de alumínio  
Acabamento cromado e polido  
Agarramento ergonômico  
Regulador de leque  
Regulador de fluido  
Regulador de pressão



	<b>WK500910</b> 25 / 001-024.800
	≥ 2 HP
	3 - 4 BAR
	8 BAR
	BSP 1/4"
	150-250 LPM
	2 MM
	3000-10000 ML
	CE
	8 424835 009014

## Pistola pintar gravedad gotelé

### Gravity hopper paint spray gun









Pistola pintar gravidade gotelé

**Cuerpo de aluminio**  
**Acabado cromado y pulido**  
**Agarre ergonómico**  
**Regulador de fluido**  
**Regulador de presión**  
**Válvula integrada de corte de aire**

Aluminium body  
Polished chrome finish  
Ergonomic grip  
Fluid regulator  
Pressure regulator  
Integrated air cut valve

Corpo de alumínio  
Acabamento cromado e polido  
Agarramento ergonômico  
Regulador de fluido  
Regulador de pressão  
Válvula integrada de corte de ar



	<b>WK500660</b> 6 / 001-019.800
	≥ 2 HP
	4 - 8 BAR
	8 BAR
	BSP 1/4"
	300 LPM
	4 / 6 / 8 MM
	6000 ML
	CE
	8 424835 001766

# Juego pistolas pintar gravedad HVLP-I

## HVLP-I gravity paint spray gun set

Jogo pistolas pintar gravidade HVLP-I

**Cuerpo de acero**

**Acabado cromado y pulido**

**Agarre ergonómico**

**Regulador de abanico**

**Regulador de fluido**

**Regulador de presión**

**Incluye manómetro**

**Incluye kit de limpieza**

**Incluye maletín de transporte**

Steel body

Polished chrome finish

Ergonomic grip

Pattern regulator

Fluid regulator

Pressure regulator

Includes manometer

Includes cleaning kit

Includes transportation case

Corpo de aço

Acabamento cromado e polido

Agarramento ergonômico

Regulador de leque

Regulador de fluido











Regulador de pressão

Inclui manômetro

Inclui kit de limpeza

Inclui mala de transporte



	<b>WK500230</b> 10 / 001-033.500
	≥ 1.5 HP
	2.5 - 3.5 / 3 - 4 BAR
	8 BAR
	BSP 1/4"
	100 / 175 LPM
	0.8 / 1.7 MM
	125 / 600 ML
	CE
	8 424835 006426

**HVLP-I (alto volumen a baja presión) reduce el consumo del producto a pulverizar un 30%, acorta el tiempo de trabajo un 20%, disminuye el consumo de aire un 15% y genera una buena calidad de pulverización y acabado.**

HVLP-I (high volume at low pressure) reduces the consumption of the product to be sprayed by 30%, shortens the working time by 20%, reduces air consumption by 15% and generates a good quality of spray and finish.

HVLP-I (alto volumen a baixa pressão) reduz o consumo do produto a ser pulverizado em 30%, reduz o tempo de trabalho em 20%, reduz o consumo de ar em 15% e gera uma boa qualidade de pulverização e acabamento.

## Juego paso fluido

### Fluid nozzle set

Jogo passagem fluido





**Cuerpo de acero inoxidable**  
**Incluye pico fluido, boquilla y aguja**

Stainless-steel body  
Includes cap, nozzle and needle

Corpo de aço inoxidável  
Inclui bico fluido, boquilha e agulha



  
WK500730

	<b>WK500010</b> 6 / 001-002.400	<b>WK500020</b> 6 / 001-002.400	<b>WK500030</b> 6 / 001-002.400
	BSP 1"	BSP 1"	BSP 1"
	0.5 MM	0.8 MM	1.0 MM
	8 424835 502515	8 424835 000554	8 424835 000561

## Juego paso fluido

### Fluid nozzle set

Jogo passagem fluido





**Cuerpo de acero inoxidable**  
**Incluye pico fluido, boquilla y aguja**

Stainless-steel body  
Includes cap, nozzle and needle

Corpo de aço inoxidável  
Inclui bico fluido, boquilha e agulha



  
WK500740

	<b>WK500040</b> 6 / 001-002.800	<b>WK500050</b> 6 / 001-002.800	<b>WK500060</b> 6 / 001-002.800
	BSP 1/3"	BSP 1/3"	BSP 1/3"
	1.4 MM	1.7 MM	2.0 MM
	8 424835 000905	8 424835 000516	8 424835 000912

## Juego paso fluido

### Fluid nozzle set

Jogo passagem fluido





**Cuerpo de acero inoxidable**  
**Incluye pico fluido, boquilla y aguja**

Stainless-steel body  
Includes cap, nozzle and needle

Corpo de aço inoxidável  
Inclui bico fluido, boquilha e agulha



  
WK500750

	<b>WK500070</b> 6 / 001-003.000	<b>WK500090</b> 6 / 001-003.000	<b>WK500100</b> 6 / 001-003.000
	BSP 1/3"	BSP 1/3"	BSP 1/3"
	1.4 MM	1.7 MM	2.0 MM
	8 424835 000929	8 424835 002299	8 424835 002244

## Juego paso fluido

### Fluid nozzle set

Jogo passagem fluido





**Cuerpo de acero inoxidable**  
**Incluye pico fluido, boquilla y aguja**

Stainless-steel body  
Includes cap, nozzle and needle

Corpo de aço inoxidável  
Inclui bico fluido, boquilha e agulha



  
WK501100

	<b>WK501130</b> 6 / 001-003.500	<b>WK501140</b> 6 / 001-003.500	<b>WK501150</b> 6 / 001-003.500
	BSP 1"	BSP 1"	BSP 1"
	0.5 MM	0.8 MM	1.0 MM
	8 424835 009489	8 424835 009496	8 424835 009502

## Juego paso fluido

### Fluid nozzle set

Jogo passagem fluido





**Cuerpo de acero inoxidable**  
**Incluye pico fluido, boquilla y aguja**

Stainless-steel body  
Includes cap, nozzle and needle

Corpo de aço inoxidável  
Inclui bico fluido, boquilha e agulha



  
WK501080

	<b>WK501020</b> 6 / 001-004.500	<b>WK501030</b> 6 / 001-004.500	<b>WK501040</b> 6 / 001-004.500
	BSP 1/3"	BSP 1/3"	BSP 1/3"
	1.4 MM	1.7 MM	2.0 MM
	8 424835 009427	8 424835 009434	8 424835 009441

## Juego paso fluido

### Fluid nozzle set

Jogo passagem fluido





**Cuerpo de acero inoxidable**  
**Incluye pico fluido, boquilla y aguja**

Stainless-steel body  
Includes cap, nozzle and needle

Corpo de aço inoxidável  
Inclui bico fluido, boquilha e agulha



  
WK501090

	<b>WK501050</b> 6 / 001-004.700	<b>WK501060</b> 6 / 001-004.700	<b>WK501070</b> 6 / 001-004.700
	BSP 1/3"	BSP 1/3"	BSP 1/3"
	1.4 MM	1.7 MM	2.0 MM
	8 424835 009458	8 424835 009465	8 424835 009472

## Filtro pistola pintar gravedad

### Gravity paint spray gun filter

Filtro pistola pintar gravidade

**Cuerpo de HDPE y acero inoxidable**

**Compatible con pistolas de pintar de gravedad universales**





HDPE and stainless-steel body

Compatible with universal gravity paint spray guns

Corpo de HDPE e aço inoxidável

Compatível com pistolas de pintar por gravidade universais



	<b>WK500250</b> 6 / 006-001.600
	36 MM
	11 MM
PCS	10
	8 424835 006464



WK500730  
WK500740  
WK501100  
WK501080  
WK501000  
WK500470  
WK500230

## Depósito gravedad

### Gravity cup

Depósito gravidade

**Cuerpo de HDPE**

**Compatible con pistolas de pintar de gravedad universales**





HDPE body

Compatible with universal gravity paint spray guns

Corpo de HDPE

Compatível com pistolas de pintar por gravidade universais



	<b>WK500170</b> 6 / 001-001.900	<b>WK500180</b> 6 / 001-002.900
	125 ML	600 ML
	BSP 3/8"	BSP 1/2"
	8 424835 003463	8 424835 003470



WK500730  
WK500740  
WK501100  
WK501080  
WK501000  
WK500470  
WK500230

# Pulverizador cemento-estuco

## Cement-stucco sprayer

Pulverizador cimento-estruque

**Cuerpo de aluminio**

**Agarre ergonómico antideslizante**

**Mango auxiliar**

**Incluye 4 boquillas integradas**

Aluminium body

Ergonomic non-slip grip

Auxiliary handle

Includes 4 built-in tips











Corpo de alumínio

Agarramento ergonômico antiderrapante

Cabo auxiliar

Inclui 4 boquilhas integradas



	<b>WK500920</b> 2 / 001-048.000
	≥ 2 HP
	5 - 8 BAR
	8 BAR
	BSP 1/4"
	225 - 375 LPM
	14 MM
	6000 ML
	700 MM
	CE
	8 424835 009021

**Recomendable para trabajos en superficies de hasta 2000 m<sup>2</sup>. Compatible con cementos, masillas, morteros, yesos y estucos.**

**Recommended for works on surfaces up to 2000 m<sup>2</sup>. Compatible with cements, putties, mortars, plasters and stuccos.**

**Recomendado para trabalhos em superfícies de até 2000 m<sup>2</sup>. Compatível com cimentos, massas, argamassas, gessos e estuques.**

# Equipo eléctrico airless

## Airless electric equipment

### Equipamento elétrico airless

**Cuerpo de ABS y aluminio**

**Agarre ergonómico antideslizante**

**Regulador de fluido**

**Regulador de presión**

**Fácilmente transportable**

**Incluye pistola de pintar airless WK500490**

**Incluye manguera airless de 7.5 metros**

**Incluye depósito antigoteo extraíble**

ABS and aluminium body

Ergonomic non-slip grip

Fluid regulator

Pressure regulator

Easily transportable

Includes airless paint spray gun WK500490

Includes 7.5-meter airless hose

Includes removable non-drip cup

Corpo de ABS e alumínio

Agarramento ergonómico antiderrapante

Regulador de fluido

Regulador de pressão











Facilmente transportável

Inclui pistola de pintar airless WK500490

Inclui mangueira airless de 7.5 metros

Inclui depósito antigotejamento removível



	<b>WK500500</b> 1 / 001-225.000
	0.7 HP / 500 W
	120 - 170 BAR
	205 BAR
	NPS 1/4"
	1.2 LPM
	≤ 0.019"
	5 ≤ 40° C
	CE
	8 424835 008352

**Recomendable para trabajos en superficies de hasta 500 m<sup>2</sup>. Compatible con barnices, lacas, esmaltes, imprimaciones, pinturas de poliuretano, pinturas acrílicas, pinturas plásticas y pinturas de caucho acrílico.**

Recommended for works on surfaces up to 500 m<sup>2</sup>. Compatible with varnishes, lacquers, enamels, primers, polyurethane paints, acrylic paints, plastic paints and acrylic rubber paints.

Recomendado para trabalhos em superfícies de até 500 m<sup>2</sup>. Compatível com vernizes, lacas, esmaltes, primers, tintas de poliuretano, tintas acrílicas, tintas plásticas e tintas de borracha acrílica.

## Equipo eléctrico airless

### Airless electric equipment

#### Equipamento elétrico airless

Cuerpo de ABS y aluminio

Agarre ergonómico antideslizante

Regulador de fluido

Regulador de presión

Fácilmente transportable

Incluye manómetro

Incluye pistola de pintar airless WK500600

Incluye manguera airless de 15 metros

Incluye alargador de 500 mm

Incluye depósito antigoteo extraíble

ABS and aluminium body

Ergonomic non-slip grip

Fluid regulator

Pressure regulator

Easily transportable

Includes manometer

Includes airless paint spray gun WK500600

Includes 15-meter airless hose

Includes 500 mm extension bar

Includes removable non-drip cup

Corpo de ABS e alumínio

Agarramento ergonômico antiderrapante

Regulador de fluido

Regulador de pressão

Fácilmente transportável

Inclui manômetro

Inclui pistola de pintar airless WK500600

Inclui mangueira airless de 15 metros

Inclui extensão de 500 mm

Inclui depósito antigotejamento removível



	<b>WK500900</b> 1 / 001-478.000
	0.7 HP / 500 W
	120 - 180 BAR
	225 BAR
	NPS 1/4"
	1.8 LPM
	≤ 0.021"
	5 ≤ 40° C
	CE
	8 424835 008475

**Recomendable para trabajos en superficies de hasta 1000 m<sup>2</sup>. Compatible con barnices, lacas, esmaltes, imprimaciones, pinturas de poliuretano, pinturas acrílicas, pinturas plásticas, pinturas de caucho acrílico, pinturas al látex y temple.**

Recommended for works on surfaces up to 1000 m<sup>2</sup>. Compatible with varnishes, lacquers, enamels, primers, polyurethane paints, acrylic paints, plastic paints, acrylic rubber paints, latex paints and temperas.

Recomendado para trabalhos em superfícies de até 1000 m<sup>2</sup>. Compatível com vernizes, lacas, esmaltes, primers, tintas de poliuretano, tintas acrílicas, tintas plásticas, tintas de borracha acrílica, tintas o látex e têmperas.



## Equipo eléctrico airless

### Airless electric equipment

#### Equipamento elétrico airless

Cuerpo de ABS y aluminio

Agarre ergonómico antideslizante

Regulador de fluido

Regulador de presión con display digital

Fácilmente transportable

Incluye pistola de pintar airless WK500600

Incluye manguera airless de 15 metros

Incluye alargador de 500 mm

Incluye depósito antigoteo extraíble

ABS and aluminium body

Ergonomic non-slip grip

Fluid regulator

Pressure regulator with digital display

Easily transportable

Includes airless paint spray gun WK500600

Includes 15-meter airless hose

Includes 500 mm extension bar

Includes removable non-drip cup

Corpo de ABS e alumínio

Agarramento ergonômico antiderrapante

Regulador de fluido

Regulador de pressão com display digital

Facilmente transportável

Inclui pistola de pintar airless WK500600

Inclui mangueira airless de 15 metros

Inclui extensão de 500 mm











Inclui depósito antigotejamento removível



**Recomendable para trabajos en superficies de hasta 1500 m<sup>2</sup>. Compatible con barnices, lacas, esmaltes, imprimaciones, pinturas de poliuretano, pinturas acrílicas, pinturas plásticas, pinturas de caucho acrílico, pinturas al látex, temple, revestimientos de techados y pinturas anticorrosivas.**

**Recommended for works on surfaces up to 1500 m<sup>2</sup>. Compatible with varnishes, lacquers, enamels, primers, polyurethane paints, acrylic paints, plastic paints, acrylic rubber paints, latex paints, temperas, roof coatings and anticorrosive paints.**

**Recomendado para trabalhos em superfícies de até 1500 m<sup>2</sup>. Compatível com vernizes, lacas, esmaltes, primers, tintas de poliuretano, tintas acrílicas, tintas plásticas, tintas de borracha acrílica, tintas o látex, temperas, coberturas de telhado e tintas anticorrosivas.**

	<b>WK501110</b> 1 / 001-584.000
	2.2 HP / 1600 W
	120 - 180 BAR
	225 BAR
	NPS 1/4"
	3 LPM
	≤ 0.023"
	5 ≤ 40° C
	CE
	8 424835 009342

## Equipo eléctrico airless

### Airless electric equipment

#### Equipamento elétrico airless

Cuerpo de ABS y aluminio

Ruedas de PU de 200 mm

Asa plegable

Regulador de fluido

Regulador de presión con display digital

Motor sin escobillas

Fácilmente transportable

Incluye pistola de pintar airless WK500600

Incluye manguera airless de 15 metros

Incluye alargador de 500 mm

ABS and aluminium body

PU wheels of 200 mm

Foldable handle

Fluid regulator

Pressure regulator with digital display

Brushless motor

Easily transportable

Includes airless paint spray gun WK500600

Includes 15-meter airless hose

Includes 500 mm extension bar

Corpo de ABS e alumínio

Rodas de PU de 200 mm

Asa dobrável

Regulador de fluido

Motor sem escovas

Regulador de pressão com display digital

Fácilmente transportável

Inclui pistola de pintar airless WK500600

Inclui mangueira airless de 15 metros

Inclui extensão de 500 mm



**Recomendable para trabajos en superficies de hasta 3000 m<sup>2</sup>. Compatible con barnices, lacas, esmaltes, imprimaciones, pinturas de poliuretano, pinturas acrílicas, pinturas plásticas, pinturas de caucho acrílico, pinturas al látex, temple, revestimientos de tejados, pinturas anticorrosivas y películas gruesas.**

*Recomendado para trabalhos em superfícies de até 3000 m<sup>2</sup>. Compatível com vernizes, lacas, esmaltes, primers, tintas de poliuretano, tintas acrílicas, tintas plásticas, tintas de borracha acrílica, tintas o látex, têmperas, coberturas de telhado, tintas anticorrosivas e películas espesas.*

	<b>WK501120</b> 1 / 001-778.000
	3.8 HP / 2800 W
	120 - 180 BAR
	225 BAR
	NPS 1/4"
	4 LPM
	≤ 0.027"
	5 ≤ 40° C
	CE
	8 424835 009359

## Equipo eléctrico airless

### Airless electric equipment

### Equipamento elétrico airless

**Cuerpo de ABS y aluminio**

**Ruedas neumáticas de PU 300 de mm**

**Asa extensible**

**Regulador de fluido**

**Regulador de presión con display digital**

**Motor sin escobillas**

**Fácilmente transportable**

**Incluye pistola de pintar airless WK500600**

**Incluye manguera airless de 30 metros**

**Incluye alargador de 1 metro**

ABS and aluminium body

Pneumatic PU wheels of 300 mm

Extendable handle

Fluid regulator

Pressure regulator with digital display

Brushless motor

Easily transportable

Includes airless paint spray gun WK500600

Includes 30-meter airless hose

Includes 1-meter extension bar

Corpo de ABS e alumínio

Rodas pneumáticas de PU de 300 mm

Asa extensível

Regulador de fluido

Regulador de pressão com display digital

Motor sem escovas











Facilmente transportável

Inclui pistola de pintar airless WK500600

Inclui mangueira airless de 30 metros

Inclui extensão de 1 metro



	<b>WK501200</b> 1 / 001-1999.000
	4 HP / 3000 W
	120 - 180 BAR
	225 BAR
	NPS 1/4"
	5 LPM
	≤ 0.031"
	5 ≤ 40° C
	CE
	8 424835 009816



**Recomendable para trabajos en superficies de hasta 5000 m<sup>2</sup>. Compatible con barnices, lacas, esmaltes, imprimaciones, pinturas de poliuretano, pinturas acrílicas, pinturas plásticas, pinturas de caucho acrílico, pinturas al látex, temple, revestimientos de tejados, pinturas anticorrosivas y películas gruesas.**

Recommended for works on surfaces up to 5000 m<sup>2</sup>. Compatible with varnishes, lacquers, enamels, primers, polyurethane paints, acrylic paints, plastic paints, acrylic rubber paints, latex paints, temperas, roof coatings, anticorrosive paints and thick layers.

Recomendado para trabalhos em superfícies de até 5000 m<sup>2</sup>. Compatível com vernizes, lacas, esmaltes, primers, tintas de poliuretano, tintas acrílicas, tintas plásticas, tintas de borracha acrílica, tintas o látex, têmperas, coberturas de telhado, tintas anticorrosivas e películas espesas.

## Equipo hidráulico airless a gasolina

### Gasoline airless hydraulic equipment

Equipamento hidráulico airless a gasolina

**Cuerpo de ABS, aluminio y acero forjado**

**Ruedas neumáticas de caucho de 330 mm**

**Asa extensible**

**Regulador de presión**

**Motor de gasolina**

**Bomba hidráulica**

**Fácilmente transportable**

**Incluye pistola de pintar airless WK501360**

**Incluye mangueras airless de 3.6 y 15 metros**

ABS, aluminium and forged steel body

Pneumatic rubber wheels of 330 mm

Extendable handle

Pressure regulator

Gasoline motor

Hydraulic pump

Easily transportable

Includes airless paint spray gun WK501360

Includes 3.6 and 15-meter airless hoses

Corpo de ABS, alumínio e aço forjado

Rodas pneumáticas de borracha de 330 mm

Asa extensível

Regulador de pressão

Motor de gasolina











Bomba hidráulica

Facilmente transportável

Inclui pistola de pintar airless WK501360

Inclui mangueiras airless de 3.6 e 15 metros



	<b>WK501400</b> 1 / 001-3325.000
	9 HP / 6700 W
	120 - 180 BAR
	225 BAR
	NPS 1/2"
	12 LPM
	≤ 0.057"
	5 ≤ 40° C
	CE
	8 424835 010102



**ajos  
'000**  
**m<sup>2</sup>. Compatible con barnices, lacas, esmaltes, imprimaciones, pinturas de poliuretano, pinturas acrílicas, pinturas plásticas, pinturas de caucho acrílico, pinturas al látex, temples, revestimientos de tejados, pinturas anticorrosivas, películas gruesas y masillas.**  
*Recommended for works on surfaces of more than 5000 m<sup>2</sup>. Compatible with varnishes, lacquers, enamels, primers, polyurethane paints, acrylic paints, plastic paints, acrylic rubber paints, latex paints, temperas, roof coatings, anticorrosive paints, thick layers and putties.*  
*Recomendado para trabalhos em superfícies de mais de 5000 m<sup>2</sup>. Compatível com vernizes, lacas, esmaltes, primers, tintas de poliuretano, tintas acrílicas, tintas plásticas, tintas de borracha acrílica, tintas o látex, têmperas, coberturas de telhado, tintas anticorrosivas, películas espesas e massas.*

## Pistola pintar airless

### Airless paint spray gun

Pistola pintar airless

**Cuerpo de aluminio**

**Agarre ergonómico antideslizante**

**Mango con protector de puño**

**Compatible con RAC-5 de Graco**

**Incluye portaboquillas**

**Incluye boquilla 517**

Aluminium body

Ergonomic non-slip grip

Fist protector handle

Compatible with RAC-5 from Graco

Includes tip holder

Includes 517 tip

Corpo de alumínio

Agarramento ergonómico antiderrapante

Cabo com protector de punho

Compatível com RAC-5 de Graco

Inclui porta-boquilhas

Inclui boquilha 517



## Pistola pintar airless

### Airless paint spray gun

Pistola pintar airless

**Cuerpo de aluminio**

**Agarre ergonómico antideslizante**

**Mango con protector de puño**

**Compatible con RAC-5 de Graco**

**Incluye portaboquillas**

**Incluye boquilla 517**

Aluminium body

Ergonomic non-slip grip

Fist protector handle

Compatible with RAC-5 from Graco

Includes tip holder

Includes 517 tip

Corpo de alumínio

Agarramento ergonómico antiderrapante

Cabo com protector de punho

Compatível com RAC-5 de Graco

Inclui porta-boquilhas









Inclui boquilha 517



**Compatible con barnices, lacas, esmaltes, imprimaciones, pinturas de poliuretano, pinturas acrílicas, pinturas plásticas, pinturas de caucho acrílico, pinturas al látex, temple, revestimientos de tejados, pinturas anticorrosivas y películas gruesas.**

Compatible with varnishes, lacquers, enamels, primers, polyurethane paints, acrylic paints, plastic paints, acrylic rubber paints, latex paints, temperas, roof coatings, anticorrosive paints and thick layers.









Compatível com vernizes, lacas, esmaltes, primers, tintas de poliuretano, tintas acrílicas, tintas plásticas, tintas de borracha acrílica, tintas o látex, têmperas, coberturas de telhado, tintas anticorrosivas e películas espesas.

	<b>WK500490</b> 20 / 001-024.500
	≥ 0.5 HP / 375 W
	60 - 160 BAR
	250 BAR
	NPS 1/4"
	BSP 7/8"
	5 ≤ 40° C
	CE
	8 424835 008345

**Compatible con barnices, lacas, esmaltes, imprimaciones, pinturas de poliuretano, pinturas acrílicas, pinturas plásticas y pinturas de caucho acrílico.**

Compatible with varnishes, lacquers, enamels, primers, polyurethane paints, acrylic paints, plastic paints and acrylic rubber paints.

Compatível com vernizes, lacas, esmaltes, primers, tintas de poliuretano, tintas acrílicas, tintas plásticas e tintas de borracha acrílica.

	<b>WK500600</b> 20 / 001-041.000
	≥ 0.5 HP / 375 W
	60 - 160 BAR
	250 BAR
	NPS 1/4"
	BSP 7/8"
	5 ≤ 40° C
	CE
	8 424835 008338

## Pistola pintar airless

### Airless paint spray gun

Pistola pintar airless

**Cuerpo de aluminio**

**Agarre ergonómico antideslizante**

**Mango con protector de puño**

**Compatible con RAC-XHD de Graco**

**Incluye portaboquillas**

**Incluye boquilla 643**

Aluminium body

Ergonomic non-slip grip

Fist protector handle

Compatible with RAC-XHD from Graco

Includes tip holder

Includes 643 tip

Corpo de alumínio

Agarramento ergonômico antiderrapante

Cabo com protector de punho

Compatível com RAC-XHD de Graco

Inclui porta-boquilhas









Inclui boquilha 643



**Compatible con barnices, lacas, esmaltes, imprimaciones, pinturas de poliuretano, pinturas acrílicas, pinturas plásticas, pinturas de caucho acrílico, pinturas al látex, temple, revestimientos de tejados, pinturas anticorrosivas, películas gruesas y masillas.**

Compatible with varnishes, lacquers, enamels, primers, polyurethane paints, acrylic paints, plastic paints, acrylic rubber paints, latex paints, temperas, roof coatings, anticorrosive paints, thick layers and putties.

Compatível com vernizes, lacas, esmaltes, primers, tintas de poliuretano, tintas acrílicas, tintas plásticas, tintas de borracha acrílica, tintas o látex, têmperas, coberturas de telhado, tintas anticorrosivas, películas espesas e massas.

	<b>WK501360</b> 20 / 001-049.000
	≥ 1 HP / 750 W
	90 - 210 BAR
	310 BAR
	NPS 3/8"
	BSP 7/8"
	5 ≤ 40° C
	CE
	8 424835 010119



## Pistola pintar airless in-line

### In-line airless paint spray gun

Pistola pintar airless in-line

**Cuerpo de aluminio**

**Agarre ergonómico antideslizante**

**Mango con protector de puño**

**Compatible con RAC-5 de Graco**

**Incluye portaboquillas**

**Incluye boquilla 517**

Aluminium body

Ergonomic non-slip grip

Fist protector handle

Compatible with RAC-5 from Graco

Includes tip holder

Includes 517 tip

Corpo de alumínio

Agarramento ergonómico antiderrapante

Cabo com protector de punho

Compatível com RAC-5 de Graco

Inclui porta-boquilhas









Inclui boquilha 517



**Compatible con barnices, lacas, esmaltes, imprimaciones, pinturas de poliuretano, pinturas acrílicas, pinturas plásticas, pinturas de caucho acrílico, pinturas al látex, temple, revestimientos de tejados, pinturas anticorrosivas y películas gruesas.**

Compatible with varnishes, lacquers, enamels, primers, polyurethane paints, acrylic paints, plastic paints, acrylic rubber paints, latex paints, temperas, roof coatings, anticorrosive paints and thick layers.

Compatível com vernizes, lacas, esmaltes, primers, tintas de poliuretano, tintas acrílicas, tintas plásticas, tintas de borracha acrílica, tintas o látex, têmperas, coberturas de telhado, tintas anticorrosivas e películas espesas.

	<b>WK501500</b> 20 / 001-046.000
	≥ 0.5 HP / 375 W
	80 - 160 BAR
	250 BAR
	NPS 1/4"
	BSP 7/8"
	5 ≤ 40° C
	CE
	8 424835 010584

## Pistola pintar airless aire-asistido

### Air-assisted airless paint spray gun

Pistola pintar airless ar-assistido

**Cuerpo de aluminio**

**Agarre ergonómico**

**Mango con protector de puño**

**Compatible con RAC-5 de Graco**

**Incluye portaboquillas**

**Incluye boquilla 517**

Aluminium body

Ergonomic grip

Fist protector handle

Compatible with RAC-5 from Graco

Includes tip holder

Includes 517 tip

Corpo de alumínio

Agarramento ergonômico

Cabo com protector de punho

Compatível com RAC-5 de Graco

Inclui porta-boquilhas









Inclui boquilha 517



**Compatible con barnices, lacas, esmaltes, imprimaciones, pinturas de poliuretano, pinturas acrílicas, pinturas plásticas, pinturas de caucho acrílico, pinturas al látex, temples, revestimientos de techados, pinturas anticorrosivas y películas gruesas.**

Compatible with varnishes, lacquers, enamels, primers, polyurethane paints, acrylic paints, plastic paints, acrylic rubber paints, latex paints, temperas, roof coatings, anticorrosive paints and thick layers.

Compatível com vernizes, lacas, esmaltes, primers, tintas de poliuretano, tintas acrílicas, tintas plásticas, tintas de borracha acrílica, tintas o látex, têmperas, coberturas de telhado, tintas anticorrosivas e películas espesas.

	<b>WK501540</b> 20 / 001-070.000
	≥ 0.5 HP / 375 W
	80 - 160 BAR
	230 BAR
	NPS 1/4"
	BSP 7/8"
	5 ≤ 40° C
	CE
	8 424835 010591

## Boquilla pistola pintar airless

### Airless paint spray gun tip

Boquilha pistola pintar airless

**Cuerpo de carburo tungsteno**

**Compatible con RAC-5 de Graco**

**Incluye junta de sellado de boquilla**

Tungsten carbide body



Compatible with RAC-5 from Graco



Includes tip seal gasket



Corpo de carburado tungstênio



Compatível com RAC-5 de Graco



Inclui junta de selado de boquilha



	<b>WK501170</b> 6 / 001-008.000	<b>WK500930</b> 6 / 001-008.000
	211	213
	8 424835 009786	8 424835 009281

	<b>WK500880</b> 6 / 001-008.000	<b>WK500890</b> 6 / 001-008.000	<b>WK500940</b> 6 / 001-008.000
	313	315	317
	8 424835 008536	8 424835 008543	8 424835 009298

	<b>WK501370</b> 6 / 001-008.000	<b>WK500540</b> 6 / 001-008.000	<b>WK500550</b> 6 / 001-008.000	<b>WK500560</b> 6 / 001-008.000	<b>WK500570</b> 6 / 001-008.000	<b>WK500950</b> 6 / 001-008.000
	413	415	417	419	421	423
	8 424835 010126	8 424835 008437	8 424835 008444	8 424835 008451	8 424835 008468	8 424835 009304

	<b>WK501380</b> 6 / 001-008.000	<b>WK500630</b> 6 / 001-008.000	<b>WK500640</b> 6 / 001-008.000	<b>WK500650</b> 6 / 001-008.000	<b>WK500860</b> 6 / 001-008.000	<b>WK500970</b> 6 / 001-008.000
	513	515	517	519	521	523
	8 424835 010133	8 424835 008505	8 424835 008512	8 424835 008529	8 424835 008482	8 424835 009328

	<b>WK501390</b> 6 / 001-008.000	<b>WK501180</b> 6 / 001-008.000	<b>WK501190</b> 6 / 001-008.000	<b>WK501210</b> 6 / 001-008.000	<b>WK501220</b> 6 / 001-008.000	<b>WK501230</b> 6 / 001-008.000
	613	615	617	619	621	623
	8 424835 010140	8 424835 009793	8 424835 009809	8 424835 009823	8 424835 009830	8 424835 009847

	<b>WK501250</b> 6 / 001-008.000	<b>WK501260</b> 6 / 001-008.000
	723	725
	8 424835 009861	8 424835 009878



**WK500490**  
**WK500600**  
**WK501500**  
**WK501540**



	<b>WK500960</b> 6 / 001-008.000	<b>WK501410</b> 6 / 001-008.000	<b>WK501440</b> 6 / 001-008.000
	425	427	429
	8 424835 009311	8 424835 010157	8 424835 010188

	<b>WK500980</b> 6 / 001-008.000	<b>WK501420</b> 6 / 001-008.000	<b>WK501450</b> 6 / 001-008.000
	525	527	529
	8 424835 009335	8 424835 010164	8 424835 010195

	<b>WK501240</b> 6 / 001-008.000	<b>WK501430</b> 6 / 001-008.000	<b>WK501460</b> 6 / 001-008.000
	625	627	629
	8 424835 009854	8 424835 010171	8 424835 010201

**El primer número indica el ángulo. Por ejemplo, 5 corresponde a 50°. Para obtener el ancho del abanico, multiplique el número del ángulo por 5. Por ejemplo, 5x5=25 cm. Los segundos dos números indican el flujo de pintura. Por ejemplo, 17 corresponde a un diámetro de 0.017".**

The first number indicates the angle. For example, 5 corresponds to 50°. To obtain the fan width, multiply the angle number by 5. In this case, 5x5=25 cm. The second two numbers indicate the paint flow. For example, 17 corresponds to a diameter of 0.017".

O primeiro número indica o ângulo. Por exemplo, 5 corresponde a 50°. Para obter a largura do leque, multiplique o número do ângulo por 5. Neste caso, 5x5=25 cm. Os segundos dois números indicam o fluxo de tinta. Por exemplo, 17 corresponde a um diâmetro de 0.017".

# Boquilla pistola pintar airless

## Airless paint spray gun tip

Boquilha pistola pintar airless



**Cuerpo de carburo tungsteno**  
**Compatible con RAC-XHD de Graco**  
**Incluye junta de sellado de boquilla**

Tungsten carbide body  
 Compatible with RAC-XHD from Graco  
 Includes tip seal gasket

Corpo de carburado tungstênio  
 Compatível com RAC-XHD de Graco  
 Inclui junta de selado de boquilha



**El primer número indica el ángulo. Por ejemplo, 5 corresponde a 50°. Para obtener el ancho del abanico, multiplique el número del ángulo por 5. Por ejemplo, 5x5=25 cm. Los segundos dos números indican el flujo de pintura. Por ejemplo, 17 corresponde a un diámetro de 0.017".**

The first number indicates the angle. For example, 5 corresponds to 50°. To obtain the fan width, multiply the angle number by 5. In this case, 5x5=25 cm. The second two numbers indicate the paint flow. For example, 17 corresponds to a diameter of 0.017".

O primeiro número indica o ângulo. Por exemplo, 5 corresponde a 50°. Para obter a largura do leque, multiplique o número do ângulo por 5. Neste caso, 5x5=25 cm. Os segundos dois números indicam o fluxo de tinta. Por exemplo, 17 corresponde a um diâmetro de 0.017".

	<b>WK501470</b> 6 / 001-008.000	<b>WK501480</b> 6 / 001-008.000
	535	539
	8 424835 010218	8 424835 010225

	<b>WK501490</b> 6 / 001-008.000	<b>WK501510</b> 6 / 001-008.000	<b>WK501520</b> 6 / 001-008.000	<b>WK501530</b> 6 / 001-008.000
	635	639	643	647
	8 424835 010232	8 424835 010249	8 424835 010256	8 424835 010263

## Portaboquillas giratorio pistola pintar airless

### Airless paint spray gun swivel tip holder

Porta-boquilhas giratório pistola pintar airless

**Cuerpo de acero inoxidable**

**Compatible con RAC-5 y RAC-XHD de Graco**

**Incluye portaboquillas y boquilla 517**

Stainless-steel body

Compatible with RAC-5 and RAC-XHD from Graco

Includes tip holder and 517 tip

Corpo de aço inoxidável

Compatível com RAC-5 e RAC-XHD de Graco

Inclui porta-boquilhas e boquilha 517



	<b>WK500870</b> 6 / 001-019.800
	BSP 7/8"
	250 BAR
	-5 ≤ 65° C
	270°
	8 424835 008499

## Portaboquillas pistola pintar airless

### Airless paint spray gun tip holder

Porta-boquilhas pistola pintar airless

**Cuerpo de acero inoxidable**

**Compatible con RAC-5 y RAC-XHD de Graco**

Stainless-steel body

Compatible with RAC-5 and RAC-XHD from Graco

Corpo de aço inoxidável

Compatível com RAC-5 e RAC-XHD de Graco



	<b>WK500460</b> 6 / 001-005.400
	BSP 7/8"
	250 BAR
	-5 ≤ 65° C
	8 424835 008406

## Junta sellado boquilla airless

### Airless tip seal gasket

Junta selado boquilha airless

**Cuerpo de acero y teflón**

**Compatible con RAC-5 y RAC-XHD de Graco**

Steel and teflon body

Compatible with RAC-5 and RAC-XHD from Graco

Corpo de aço e teflon

Compatível com RAC-5 e RAC-XHD de Graco



	<b>WK501350</b> 12 / 001-005.500
PCS	5
	8 424835 010270

## Filtro malla airless

### Airless mesh filter

#### Filtro malha airless

**Cuerpo de HDPE y acero inoxidable**

**Compatible con pistolas airless de Graco y Wagner**

HDPE and stainless-steel body

Compatible with Graco and Wagner airless paint spray guns

Corpo de HDPE e aço inoxidável

Compatível com pistolas airless de Graco e Wagner



WK500600  
WK501500

Ø I	<b>WK501310</b> 6 / 006-001.500	<b>WK501320</b> 6 / 006-001.500
■	#60	#100
↑ ↓	110-130 MM	110-130 MM
Ø	10 MM	10 MM
PCS	2	2
	8 424835 009922	8 424835 009939

## Filtro malla airless

### Airless mesh filter

#### Filtro malha airless

**Cuerpo de HDPE y acero inoxidable**

**Compatible con pistolas airless de Graco y Wagner**

HDPE and stainless-steel body

Compatible with Graco and Wagner airless paint spray guns

Corpo de HDPE e aço inoxidável

Compatível com pistolas airless de Graco e Wagner



WK500490  
WK501360

Ø I	<b>WK501270</b> 6 / 006-001.500	<b>WK501280</b> 6 / 006-001.500	<b>WK501290</b> 6 / 006-001.500	<b>WK501300</b> 6 / 006-001.500
■	#50	#80	#100	#150
↑ ↓	102 MM	102 MM	102 MM	102 MM
Ø	10 MM	10 MM	10 MM	10 MM
PCS	2	2	2	2
	8 424835 009885	8 424835 009892	8 424835 009908	8 424835 009915

## **Alargador pistola pintar airless** Airless paint spray gun extension bar Alargador pistola pintar airless

**Cuerpo de aluminio**  
**Incluye protectores de rosca**

Aluminium body  
Includes thread protectors

Corpo de alumínio  
Inclui protetores de rosca



Ø L	<b>WK500510</b> 5 / 001-004.200	<b>WK500520</b> 5 / 001-005.000	<b>WK501330</b> 5 / 001-006.800	<b>WK501340</b> 5 / 001-010.400
↕	300 MM	600 MM	1000 MM	1800 MM
∅	5 X 12 MM	5 X 12 MM	5 X 12 MM	5 X 12 MM
→ ←	BSP 7/8"	BSP 7/8"	BSP 7/8"	BSP 7/8"
⊙ MAX	280 BAR	280 BAR	280 BAR	280 BAR
°	-5 ≤ 65° C	-5 ≤ 65° C	-5 ≤ 65° C	-5 ≤ 65° C
	8 424835 008314	8 424835 008321	8 424835 009571	8 424835 009588

## **Manguera airless** Airless hose Mangueira airless

**Cuerpo de caucho y fibra de vidrio**  
**Conexiones de rosca hembra**  
**Ligera y flexible**

Rubber and fibreglass body  
Female thread connections  
Light and flexible

Corpo de borracha e fibra de vidro  
Conexões de rosca fêmea  
Leve e flexível



Ø L	<b>WK500610</b> 5 / 001-022.600	<b>WK500620</b> 3 / 001-038.600
↕	7.5 M	15 M
∅	6 X 13 MM	6 X 13 MM
→ ←	NPS 1/4"	NPS 1/4"
⊙ MAX	225 BAR	225 BAR
°	-5 ≤ 65° C	-5 ≤ 65° C
	8 424835 008413	8 424835 008420



# Juego aerografía succión

## Suction airbrush set

Jogo aerografia sucção

### Regulador de fluido

Incluye 2 depósitos

Incluye manguera de 1.2 metros

Incluye dosificador de tinta

Incluye maletín de transporte

### Fluid regulator

Includes 2 cups

Includes 1.2-meter hose

Includes ink dispenser

Includes transportation case

### Regulador de fluido











Inclui 2 depósitos

Inclui mangueira de 1.2 metros

Inclui dosificador de tinta

Inclui mala de transporte



	<b>WK500700</b> 10 / 001-007.000
	≥ 0.15 HP
	1 - 3.5 BAR
	4 BAR
	M 5
	4-8 LPM
	0.40 MM
	22 ML
	CE
	8 424835 800307

# Juego aerografía succión-gravedad

## Suction-gravity airbrush set

Jogo aerografia sucção-gravidade

### Regulador de fluido

Incluye 2 depósitos

Incluye dosificador de tinta

Incluye maletín de transporte

Fluid regulator

Includes 2 cups

Includes ink dispenser

Includes transportation case











Regulador de fluido

Inclui 2 depósitos

Inclui dosificador de tinta

Inclui mala de transporte



	<b>WK500720</b> 10 / 001-016.000
	≥ 0.15 HP
	1 - 3.5 BAR
	4 BAR
	BSP 1/8"
	4-8 LPM
	0.30 MM
	7 / 22 ML
	CE
	8 424835 000998

## Mini compresor aerografía

Airbrush mini compressor

Mini compressor aerografía

**Cuerpo de aluminio y policarbonato**

**Silencioso**

**Regulador de presión**

**Fácilmente transportable**

Aluminium and polycarbonate body

Silent

Pressure regulator

Easily transportable

Corpo de alumínio e policarbonato

Silencioso

Regulador de pressão

Facilmente transportável



## Manguera neumática aerografía

Airbrush pneumatic hose

Mangueira pneumática aerografía

**Cuerpo de caucho**

**Conexiones de rosca hembra**

**Incluye adaptador de rosca macho-hembra**

Rubber body

Female thread connections

Includes male-female thread adapter

Corpo de borracha

Conexões de rosca fêmea

Inclui adaptador de rosca macho-fêmea



	<b>WK500800</b> 6 / 001-059.900
	0.15 HP
	3 - 4 BAR
	4 BAR
	BSP 1/8"
	23 LPM
	1450 RPM
	CE
	8 424835 003302

	<b>WK500220</b> 25 / 001-003.800
	3 M
	4.5 X 7.5 MM
	BSP 1/8" / M 5
	7 BAR
	-5 ≤ 60° C
	8 424835 005849

## Varilla limpieza pistola pintar Paint spray gun cleaning rod Varinha limpeza pistola pintar

**Cuerpo de acero inoxidable**  
**Incluye 5 varillas**

Stainless-steel body  
Includes 5 rods

Corpo de aço inoxidável  
Inclui 5 varinhas



	<b>WK500840</b> 10 / 001-002.200
	108 MM
	0.76-1.50 MM
	8 424835 000240

## Empuñadura aerografía Airbrush handle Empunhadura aerografia

**Cuerpo de ABS**  
**Compatible con pistolas de aerografía universales**

ABS body  
Compatible with universal airbrushes

Corpo de ABS  
Compatível com pistolas de aerografia universais



	<b>WK500850</b> 10 / 001-002.200
	BSP 1/8"
	0.05 KG
	8 424835 002480

## Soporte pistolas aerografía Airbrush gun holder Suporte pistolas aerografia

**Soportes direccionables**  
**Anclaje a mesa de trabajo**  
**Compatible con 4 aerógrafos**

Directionable holders  
Workbench anchorage  
Compatible with 4 airbrushes

Suportes direccionables  
Acoragem a mesa de trabalho  
Compatível com 4 aerógrafos



	<b>WK500810</b> 4 / 001-007.000
	116 MM
	8 424835 003555

## Juego mezclado pintura aerografía Airbrush paint mix set Jogo misturado pintura aerografia

**Cuerpo de acero inoxidable**  
**Incluye 2 recipientes**  
**Incluye 2 varillas de mezclado**

Stainless-steel body  
Includes 2 containers  
Includes 2 mixing stirrers

Corpo de aço inoxidável  
Inclui 2 recipientes  
Inclui 2 varinhas de misturado



	<b>WK500820</b> 10 / 001-002.200
	153 MM
	12 ML
	8 424835 000219

## Pistola soplar

### Blowing gun

Pistola soprar

**Cuerpo de aluminio - Acabado cromado y pulido**  
**Agarre ergonómico - Regulador de fluido**

Aluminium body - Polished chrome finish  
 Ergonomic grip - Fluid regulator

Corpo de alumínio - Acabamento cromado e polido  
 Agarramento ergo



	<b>WI</b> 10,
	≥ 0.
	6 -
	8 BAR
	BSP 1/4"
	300 LPM
	CE
	8 424835 002251

## Pistola secado

### Drying gun

Pistola secado

**Cuerpo de aluminio y ABS**  
**Regulador de presión**  
**Filtro de aire**

Aluminium and ABS body  
 Pressure regulator  
 Air filter

Corpo de alumínio e ABS  
 Regulador de pressão  
 Filtro de ar



	<b>WK500670</b> 12 / 001-021.000
	≥ 2 HP
	4 - 6 BAR
	10 BAR
	BSP 1/4"
	230-350 LPM
	5000 LPM
	CE
	8 424835 007416

## Pistola chorro arena

### Sandblasting gun

Pistola jato areia

**Cuerpo de acero carbono**  
**Agarre antideslizante**  
**Incluye 2 boquillas y manguera de succión de arena de 900 mm**

Carbon steel body  
 Non-slip grip  
 Includes 2 nozzles and 900 mm sand suction hose

Corpo de aço carbono  
 Agarramento antiderrapante  
 Inclui 2 boquilhas e mangueira de sucção de areia de 900 mm



	<b>WK500690</b> 20 / 001-011.000
	≥ 1.5 HP
	4-5 BAR
	6 BAR
	BSP 1/4"
	280 LPM
	6 MM
	CE
	8 424835 007430

## Pistola espuma

### Foam gun

Pistola espuma

**Cuerpo de aluminio y mango de caucho**  
**Agarre ergonómico antideslizante**  
**Compatible con cartuchos universales**  
**Exterior e interior totalmente recubierto de teflón**

Aluminium body and rubber handle  
 Ergonomic non-slip grip  
 Compatible with universal cartridges  
 Fully teflon coated exterior and interior

Corpo de alumínio e punho de borracha  
 Agarramento ergonômico antiderrapante  
 Compatível com cartuchos universais  
 Exterior e interior totalmente revestidos de teflon



	<b>WK501160</b> 20 / 001-007.900
	6 - 7 BAR
	14 BAR
	190 MM
	8 424835 009694

**El revestimiento de teflón proporciona una excelente protección contra el pegado de la espuma y facilita la limpieza.**

*The teflon coating provides an excellent protection against foam sticking and makes cleaning easy.*

*O revestimento de teflon oferece uma excelente proteção contra a aderência da espuma e facilita a limpeza.*

## Lijadora circular orbital

### Orbital circular sander

Lixadora circular orbital

**Cuerpo de ABS**  
**Sistema de extracción compatible con aspirador**  
**Función de giro orbital**  
**Fijación con velcro**  
**Incluye disco de lijado**  
**Incluye manguera de aspiración de 1 metro**

ABS body  
 Extraction system compatible with vacuum cleaner  
 Orbital spin function  
 Velcro fixing  
 Includes sanding disc  
 Includes 1-meter suction hose

Corpo de ABS  
 Sistema de extracção compatible com aspirador  
 Função de rotação orbital  
 Fixação com velcro  
 Inclui disco de lixado  
 Inclui mangueira de sucção de 1 metro



	<b>WK500290</b> 12 / 001-028.000
	≥ 2 HP
	5-7 BAR
	8 BAR
	BSP 1/4"
	200 LPM
	10500 RPM
	150 MM
	5 MM
	CE
	8 424835 001940

## Martillo demoledor

### Demolition hammer

Martelo demolidor

**Cuerpo de acero carbono**

**Agarre ergonómico**

**Regulador de presión**

**Incluye 5 cinceles**

**Incluye maletín de transporte**

Carbon steel body

Ergonomic grip

Pressure regulator

Includes 5 chisels

Includes transportation case

Corpo de aço carbono











Agarramento ergonômico

Regulador de pressão

Inclui 5 cinzeis

Inclui mala de transporte



	<b>WK500450</b> 10 / 001-017.500
	≥ 2 HP
	6 - 7 BAR
	7 BAR
	BSP 1/4"
	155 LPM
	3000 IPM
	HEX
	CE
	8 424835 006754

## Taladro

### Drill

Berbequim

**Cuerpo de acero carbono**

**Agarre ergonómico**

**Portabrocas automático**

**Función de rotación reversible**

Carbon steel body

Ergonomic grip

Keyless chuck

Reversible rotation function













Corpo de aço carbono

Agarramento ergonômico

Bucha automática

Função de rotação reversível



	<b>WK500590</b> 10 / 001-021.000
	≥ 2 HP
	6 - 7 BAR
	8 BAR
	BSP 1/4"
	115 LPM
	0-1800 RPM
	1-13 MM
	20 MM
	10 MM
	CE
	8 424835 007447

## Martilleta agujas

### Needle scaler

Desincrustador agulhas

**Cuerpo de acero carbono**

**Agarre ergonómico**

**Regulador de presión**

Carbon steel body

Ergonomic grip

Pressure regulator

Corpo de aço carbono

Agarramento ergonômico

Regulador de pressão



	<b>WK500580</b> 10 / 001-023.500
	≥ 2 HP
	4 - 8 BAR
	8 BAR
	BSP 1/4"
	90 LPM
	4000 IPM
	19
	40 MM
	CE
	8 424835 006778

## Pistola cartuchos tubular

### Tubular caulking gun

Pistola cartuchos tubular

**Cuerpo de acero carbono**

**Agarre ergonómico**

**Compatible con cartuchos universales**

Carbon steel body

Ergonomic grip

Compatible with universal cartridges

Corpo de aço carbono

Agarramento ergonômico

Compatível com cartuchos universais



	<b>WK500680</b> 10 / 001-013.500
	≥ 1.5 HP
	6 - 7 BAR
	8 BAR
	BSP 1/4"
	160 LPM
	300 ML
	50 MM
	225 MM
	CE
	8 424835 007423



# Pistola grapadora

## Stapler gun

Pistola agrafadora

**Cuerpo de acero carbono y aluminio**

**Agarre antideslizante**

**Incluye lubricante**

**Incluye maletín de transporte**

Carbon steel and aluminium body

Non-slip grip

Includes oil

Includes transportation case









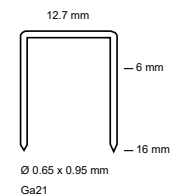



Corpo de aço carbono e alumínio

Agarramento antiderrapante

Inclui lubrificante

Inclui mala de transporte



	<b>WK500440</b> 10 / 001-029.500
	≥ 2 HP
	5 - 7.5 BAR
	8 BAR
	BSP 1/4"
	200 LPM
	0.65 X 0.95 MM
	12.7 MM
	6 - 16 MM
	100
	CE
	8 424835 006747

## Pistola clavadora

### Nailer gun

Pistola pregadora

**Cuerpo de acero carbono y aluminio**  
**Agarre antideslizante**  
**Regulador de fuerza de impacto**  
**Función de liberación rápida de atascos**  
**Expulsión de aire ajustable**  
**Incluye lubricante**  
**Incluye maletín de transporte**

Carbon steel and aluminium body  
 Non-slip grip  
 Impact force regulator  
 Quick jam release function  
 Adjustable air exhaust  
 Includes oil  
 Includes transportation case

Corpo de aço carbono e alumínio  
 Agarramento antiderrapante  
 Regulador de força de impacto  
 Função de liberação rápida de atascos  
 Expulsão de ar ajustável  
 Inclui lubrificante  
 Inclui mala de transporte



## Pistola clavadora

### Nailer gun

Pistola pregadora

**Cuerpo de acero carbono y aluminio**  
**Agarre antideslizante**  
**Regulador de fuerza de impacto**  
**Función de liberación rápida de atascos**  
**Expulsión de aire ajustable**  
**Incluye lubricante**  
**Incluye maletín de transporte**

Carbon steel and aluminium body  
 Non-slip grip  
 Impact force regulator  
 Quick jam release function  
 Adjustable air exhaust  
 Includes oil  
 Includes transportation case

Corpo de aço carbono e alumínio  
 Agarramento antiderrapante  
 Regulador de força de impacto  
 Função de liberação rápida de atascos  
 Expulsão ar ajustável  
 Inclui lubrificante  
 Inclui mala de transporte

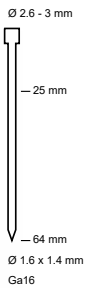

	<b>WK500780</b> 10 / 001-036.000
	≥ 2 HP
	5 - 7.5 BAR
	8 BAR
	BSP 1/4"
	200 LPM
	1.25 X 1 MM
	15 - 50 MM
	100
	CE
	8 424835 006785

	<b>WK500530</b> 05 / 001-058.500
	≥ 2 HP
	5 - 7.5 BAR
	8 BAR
	BSP 1/4"
	200 LPM
	1.6 X 1.4 MM
	25 - 64 MM
	100
	CE
	8 424835 006761

## Filtro aire

### Air filter





Filtro ar

**Cuerpo de aluminio y policarbonato**

Aluminium and polycarbonate body

Corpo de alumínio e policarbonato



	<b>WK500320</b> 10 / 001-002.800
	BSP 1/4"
	≤ 1000 LPM
	10 BAR
	8 424835 007089

## Lubricador aire

### Air lubricator





Lubrificador ar

**Cuerpo de latón y policarbonato**

Brass and polycarbonate body

Corpo de latão e policarbonato



	<b>WK500330</b> 10 / 001-002.000
	BSP 1/4"
	≤ 1000 LPM
	10 BAR
	8 424835 007096

## Regulador aire

### Air regulator

Regulador ar

**Cuerpo de aluminio y ABS**

**Medición en BAR y PSI**







Aluminium and ABS body

BAR and PSI measure

Corpo de alumínio e ABS

Medição em BAR e PSI



	<b>WK500340</b> 10 / 001-004.900
	BSP 1/4"
	≤ 1000 LPM
	0-10 BAR
	12 BAR
	8 424835 007102

## Filtro-regulador aire

### Air filter-regulator

Filtro-regulador ar

**Cuerpo de policarbonato**

**Medición en BAR y PSI**









Polycarbonate body

BAR and PSI measure

Corpo de policarbonato

Medição em BAR e PSI



	<b>WK500300</b> 05 / 001-008.600
	BSP 1/2"
	≤ 1500 LPM
	0-10 BAR
	12 BAR
	10 MIC
	5-60° C
	125 ML
	8 424835 007065

## Filtro-regulador-lubricador aire

### Air filter-regulator-lubricator

Filtro-regulador-lubrificador ar

**Cuerpo de policarbonato**

**Medición en BAR y PSI**









Polycarbonate body

BAR and PSI measure

Corpo de policarbonato

Medição em BAR e PSI



	<b>WK500310</b> 05 / 001-014.500
	BSP 1/2"
	≤ 1500 LPM
	0-10 BAR
	12 BAR
	10 MIC
	5-60° C
	125 / 125 ML
	8 424835 007072

**Enchufe rápido**  
Quick coupler  
Plugue rápido

**Cuerpo de acero inoxidable**  
**Conexión de rosca hembra**

Stainless-steel body  
Female thread connection

Corpo de aço inoxidável  
Conexão de rosca fêmea



**Enchufe rápido**  
Quick coupler  
Plugue rápido

**Cuerpo de acero inoxidable**  
**Conexión de rosca macho**

Stainless-steel body  
Male thread connection

Corpo de aço inoxidável  
Conexão de rosca macho



	<b>WK500380</b> 20 / 005-002.200
	BSP 1/4"
	8 424835 007164

	<b>WK500990</b> 20 / 005-002.200
	BSP 1/4"
	8 424835 009366

**Racor rápido**  
Quick fitting  
União rápida

**Cuerpo de acero inoxidable**  
**Conexión de rosca hembra**

Stainless-steel body  
Female thread connection

Corpo de aço inoxidável  
Conexão de rosca fêmea



**Racor rápido**  
Quick fitting  
União rápida

**Cuerpo de acero inoxidable**  
**Conexión de rosca macho**

Stainless-steel body  
Male thread connection

Corpo de aço inoxidável  
Conexão de rosca macho



	<b>WK501010</b> 20 / 005-000.600
	BSP 1/4"
	8 424835 009380

	<b>WK500390</b> 20 / 005-000.600
	BSP 1/4"
	8 424835 007171

**Racor rápido**  
Quick fitting  
União rápida

**Cuerpo de acero inoxidable**  
**Conexión de espiga**

Stainless-steel body  
Barb connection

Corpo de aço inoxidável  
Conexão de espiga



	<b>WK500400</b> 20 / 005-000.750	<b>WK500410</b> 20 / 005-000.800	<b>WK500420</b> 20 / 005-000.850
	8 MM	10 MM	12 MM
	8 424835 007188	8 424835 007195	8 424835 007201

## Espiral manguera neumática

### Pneumatic coiled hose







Espiral mangueira pneumática

**Cuerpo de poliuretano**  
**Conexiones de rosca macho**  
**Ligera y flexible**

Polyurethane body  
Male thread connections  
Light and flexible

Corpo de poliuretano  
Conexões de rosca macho  
Leve e flexível



	<b>WK500190</b> 10 / 001-005.900	<b>WK500200</b> 10 / 001-008.400
	10 M	15 M
	5 X 8 MM	5 X 8 MM
	BSP 1/4"	BSP 1/4"
	10 BAR	10 BAR
	-5 ≤ 60° C	-5 ≤ 65° C
	8 424835 000639	8 424835 003586

## Manguera neumática

### Pneumatic hose







Mangueira pneumática

**Cuerpo de poliuretano y PVC**  
**Conexiones de rosca macho**  
**Ligera y flexible**

Poliurethane and PVC body  
Male thread connections  
Light and flexible

Corpo de poliuretano e PVC  
Conexões de rosca macho  
Leve e flexível



	<b>WK500360</b> 10 / 001-011.900	<b>WK500370</b> 10 / 001-015.900
	10 M	15 M
	8 X 15 MM	8 X 15 MM
	BSP 1/4"	BSP 1/4"
	20 BAR	20 BAR
	-5 ≤ 60° C	-5 ≤ 65° C
	8 424835 002305	8 424835 000660



**Escaleras y plataformas**  
**Ladders and platforms**  
Escadas e plataformas





## Escalera multiuso

### Multipurpose ladder

Escada multiuso

**Cuerpo de aluminio**

**Tacos de goma**

**Fácilmente transportable**

**Plegable**

Aluminium body

Rubber blocks

Easily transportable

Foldable

Corpo de alumínio

Blocos de borracha

Facilmente transportável

Dobrável



## Plataforma escalera multiuso

### Multipurpose ladder platform

Plataforma escada multiuso

**Cuerpo de acero galvanizado**

**Fácilmente montable**

**Antideslizante**

Galvanized Steel body

Easily mountable

Non-slip

Corpo de aço galvanizado

Facilmente montável

Anti-deslizante

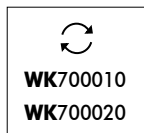

	<b>WK700010</b> 1 / 001-089.200	<b>WK700020</b> 1 / 001-111.200
	150 KG	150 KG
	372 CM	472 CM
	102 CM	127 CM
	180 CM	226 CM
	102 CM	127 CM
	4 X 3	4 X 4
	26 CM	26 CM
	35 CM	35 CM
	1.2 MM	1.2 MM
	EN 131-4	EN 131-4
	8 424835 000646	8 424835 000950

	<b>WK700070</b> 10 / 001-010.200	<b>WK700080</b> 10 / 001-013.200
	150 KG	150 KG
	150 CM	205 CM
	32 CM	32 CM
	1 MM	1 MM
	8 424835 006280	8 424835 006297

# Escalera telescópica multiuso

## Telescopic multipurpose ladder

Escada telescópica multiuso

**Cuerpo de aluminio**

**Tacos de goma**

**Fácilmente transportable**

**Extensible**

**Plegable**

Aluminium body

Rubber blocks

Easily transportable

Extendable

Foldable

Corpo de alumínio

Blocos de borracha

Facilmente transportável

Extensível

Dobrável



	<b>WK700110</b> 1 / 001-113.000	<b>WK700120</b> 1 / 001-133.000
	150 KG	150 KG
	398 CM	510 CM
	120 CM	148 CM
	194 CM	247 CM
	102 CM	127 CM
	2 X 4+4	2 X 5+5
	28 CM	28 CM
	35 CM	35 CM
	1.2 / 1.5 MM	1.2 / 1.5 MM
	EN 131-4	EN 131-4
	8 424835 006808	8 424835 006792

## Plataforma-andamio móvil

### Mobile platform-scaffold

Plataforma-andaime móvel

**Cuerpo de aluminio**

**Plataforma de madera**

**Tacos de goma**

**Ruedas de ABS de 100 mm**

**Fácilmente transportable**

**Plegable**

**Antideslizante**

Aluminium body

Wooden platform

Rubber blocks

ABS wheels of 100 mm

Easily transportable

Foldable

Non-slip

Corpo de alumínio

Plataforma de madeira

Blocos de borracha









Rodas de ABS de 100 mm

Facilmente transportável

Dobrável

Anti-deslizante



	<b>WK700130</b> 1 / 001-117.200
	150 KG
	150 CM
	90 CM
	100 X 40 CM
	1.2 MM
	EN 131-7
	8 424835 008291

## Plataforma

### Platform

Plataforma

**Cuerpo de aluminio**

**Tacos de goma**

**Fácilmente transportable**

**Plegable**

**Antideslizante**

Aluminium body

Rubber blocks

Easily transportable

Foldable

Non-slip

Corpo de alumínio







Blocos de borracha

Facilmente transportável

Dobrável

Anti-deslizante



	<b>WK700160</b> 1 / 001-061.500	<b>WK700170</b> 1 / 001-066.500
	150 KG	150 KG
	75 CM	75 CM
	75 X 45 CM	100 X 45 CM
	1.5 MM	1.5 MM
	EN 14183	EN 14183
	8 424835 010072	8 424835 010089

## Escalera ancha

### Wide ladder

Escada larga

**Cuerpo de acero carbono**

**Asa acolchada de caucho**

**Tacos de goma**

**Fácilmente transportable**

**Plegable**

**Antideslizante**

Carbon steel body

Rubber padded handle

Rubber blocks

Easily transportable

Foldable

Non-slip

Corpo de aço carbono

Alça acolchoada de borracha

Blocos de borracha

Facilmente transportável

Dobrável

Anti-deslizante



## Escalera telescópica

### Telescopic ladder

Escada telescópica

**Cuerpo de aluminio**

**Tacos de goma**

**Fácilmente transportable**

**Extensible**

**Función de cierre suave**

Aluminium body

Rubber blocks

Easily transportable

Extendable

Soft close function

Corpo de alumínio

Blocos de borracha

Facilmente transportável

Extensível

Função de cierre suave



	<b>WK700090</b> 4 / 001-030.500	<b>WK700100</b> 4 / 001-036.500
	150 KG	150 KG
	89 CM	110 CM
	46 CM	46 CM
	2	3
	48 CM	70 CM
	26 X 38 CM	26 X 38 CM
	1.2 MM	1.2 MM
	EN 14183	EN 14183
	8 424835 006167	8 424835 006198

	<b>WK700140</b> 1 / 001-080.500	<b>WK700150</b> 1 / 001-094.500
	150 KG	150 KG
	85-320 CM	91-380 CM
	47 / 81 CM	47 / 86 CM
	10	12
	29 CM	29 CM
	1.3 MM	1.3 MM
	EN 131-6	EN 131-6
	8 424835 009618	8 424835 009625



**Protección y seguridad**  
**Protection and safety**  
Proteção e segurança



**Mascarilla****Mask**

Máscara

**Cuerpo de polipropileno**  
**Clip nasal de acero inoxidable**  
**Almohadilla interior**  
**Bandas elásticas**

Polypropylene body  
 Stainless-steel nose clip  
 Inner pad  
 Elastic bands

Corpo de polipropileno  
 Clipe nasal de aço inoxidável  
 Almofadinha interior  
 Bandas elásticas



	<b>WK100130</b> 20 / 001-003.900
	FFP1
	3
	4 X TLV
PCS	10
	CE CAT-II
	8 424835 001278

**Producto relacionado con Covid-19. Puede no haber stock.**  
 Covid-19 related product. There may be no stock.

Produto relacionado com Covid-19.  
 Pode não haver estoque.

**Mascarilla****Mask**

Máscara

**Cuerpo de polipropileno**  
**Válvula de exhalación**  
**Clip nasal de acero inoxidable**  
**Almohadilla interior**  
**Bandas elásticas**

Polypropylene body  
 Exhalation valve  
 Stainless-steel nose clip  
 Inner pad  
 Elastic bands

Corpo de polipropileno  
 Válvula de exalação  
 Clipe nasal de aço inoxidável  
 Almofadinha interior  
 Bandas elásticas



	<b>WK100150</b> 20 / 001-004.800	<b>WK100160</b> 20 / 001-005.400
	FFP1	FFP2
	3	3
	4 X TLV	12 X TLV
PCS	10	10
	CE CAT-II	CE CAT-II
	8 424835 004705	8 424835 004699

**Producto relacionado con Covid-19. Puede no haber stock.**  
 Covid-19 related product. There may be no stock.

Produto relacionado com Covid-19.  
 Pode não haver estoque.

**Mascarilla****Mask**

## Máscara

**Cuerpo de polipropileno**  
**Válvula de exhalación**  
**Capa intermedia de carbón activo**  
**Clip nasal de acero inoxidable**  
**Almohadilla interior**  
**Bandas elásticas**

Polypropylene body  
 Exhalation valve  
 Intermediate layer of activated carbon  
 Stainless-steel nose clip  
 Inner pad  
 Elastic bands

Corpo de polipropileno  
 Válvula de exalação  
 Camada intermédia de carvão ativado  
 Clipe nasal de aço inoxidável  
 Almofadinha interior  
 Bandas elásticas



	<b>WK100200</b> 20 / 001-005.900
	FFP2
	4
	12 X TLV
PCS	10
	CE CAT-II
	8 424835 004675

**Producto relacionado con Covid-19. Puede no haber stock.**  
 Covid-19 related product. There may be no stock.

Produto relacionado com Covid-19.  
 Pode não haver estoque.



# Mascarilla

## Mask

### Máscara

**Cuerpo de polipropileno**

**Válvula de exhalación**

**Clip nasal de acero inoxidable**

**Almohadilla interior**

**Acolchado interior**

**Bandas anchas elásticas y ajustables**

Polypropylene body

Exhalation valve

Stainless-steel nose clip

Inner pad

Interior padded

Wide elastic and adjustable bands

Corpo de polipropileno

Válvula de exalação

Clipe nasal de aço inoxidável

Almofadinha interior

Acolchoado interior

Bandas largas elásticas e ajustáveis



	<b>WK100580</b> 40 / 001-008.400
	FFP3
	3
	50 X TLV
PCS	5
	CE CAT-III
	8 424835 007928

**Producto relacionado con Covid-19. Puede no haber stock.**  
Covid-19 related product. There may be no stock.

Produto relacionado com Covid-19.  
Pode não haver estoque.

**Mascarilla****Mask**

## Máscara

**Cuerpo de polipropileno****Válvula de exhalación****Capa intermedia de carbón activo****Clip nasal de acero inoxidable****Almohadilla interior****Acolchado interior****Bandas anchas elásticas y ajustables**

Polypropylene body

Exhalation valve

Intermediate layer of activated carbon

Stainless-steel nose clip

Inner pad

Interior padded

Wide elastic and adjustable bands

Corpo de polipropileno

Válvula de exalação

Camada intermédia de carvão ativado

Clípe nasal de aço inoxidável

Almofadainha interior

Acolchoado interior

Bandas largas elásticas e ajustáveis



	<b>WK100690</b> 40 / 001-008.900
	FFP3
	4
	50 X TLV
PCS	5
	CE CAT-III
	8 424835 007935

**Producto relacionado con Covid-19. Puede no haber stock.**  
Covid-19 related product. There may be no stock.

Produto relacionado com Covid-19.  
Pode não haver estoque.

## Buzo desechable Disposable overall





Macação descartável

**Cuerpo de polipropileno**  
**Transpirable e impermeable**  
**Costuras termoselladas**  
**Cierre con cremallera**

Polypropylene body  
Breathable and waterproof  
Thermo-sealed seams  
Zipper closing

Corpo de polipropileno  
Transpirável e impermeável  
Costuras termoseladas  
Fechamento com zíper



	<b>WK100750</b> 50 / 010-001.900	<b>WK100760</b> 50 / 010-001.900	<b>WK100770</b> 50 / 010-001.900
	55 GR/M <sup>2</sup>	55 GR/M <sup>2</sup>	55 GR/M <sup>2</sup>
	M	L	XL
	CE CAT-I	CE CAT-I	CE CAT-I
	8 424835 003081	8 424835 003050	8 424835 003661

**Producto relacionado con  
Covid-19. Puede no haber stock.**  
Covid-19 related product. There  
may be no stock.

Produto relacionado com Covid-19.  
Pode não haver estoque.

# Buzo desechable

## Disposable overall

Macação descartável

**Cuerpo de polipropileno SMS**

**Transpirable e impermeable**

**Costuras termoselladas**

**Cierre con cremallera**

**Protección contra polvo; partículas sólidas aéreas (tipo 5)**

**Protección contra líquidos; ligeras salpicaduras líquidas (tipo 6)**

SMS polypropylene body

Breathable and waterproof

Thermo-sealed seams

Zipper closing

Dust protection; solid airborne particles (type 5)

Liquid protection; light liquid splashes (type 6)

Corpo de polipropileno SMS

Transpirável e impermeável

Costuras termoseladas

Fechamento com zíper

Proteção contra pó; partículas sólidas aéreas (tipo 5)

Proteção contra líquidos; leves salpicos líquidos (tipo 6)

EN 13034

EN ISO 13688

EN ISO 13688



TYPE 5



TYPE 6



	<b>WK100420</b> 50 / 010-003.500	<b>WK100430</b> 50 / 010-003.500	<b>WK100440</b> 50 / 010-003.500
	55 GR/M <sup>2</sup>	55 GR/M <sup>2</sup>	55 GR/M <sup>2</sup>
	M	L	XL
	CE CAT-III	CE CAT-III	CE CAT-III
	8 424835 003944	8 424835 003791	8 424835 001490

**Producto relacionado con Covid-19. Puede no haber stock.**  
Covid-19 related product. There may be no stock.

Produto relacionado com Covid-19.  
Pode não haver estoque.

## Pantalón corto

### Short trouser

Calça curta

**Cuerpo de 65% poliéster y 35% algodón**

**Refuerzos de doble costura**

**Fondo blanco, con bolsillos y costuras en negro**

**Cierre con cremallera y botón - Cintura elástica**

**Transpirable**

**Incluye 6 bolsillos**

65% polyester and 35% cotton body

Double-stitched gussets

White background, with black pockets and stitchings

Zipper and button closing - Elastic waist

Breathable

Includes 6 pockets

Corpo de 65% poliéster e 35% algodão

Reforços de costura dupla

Fundo branco, com bolsos e costuras em preto

Fechamento com zíper e botão - Cintura elástica

Respirável

Inclui 6 bolsos



	<b>WK101010</b> 25 / 001-007.200	<b>WK101020</b> 25 / 001-007.200	<b>WK101030</b> 25 / 001-007.200	<b>WK101040</b> 25 / 001-007.200	<b>WK101050</b> 25 / 001-007.200
	240 GR/M <sup>2</sup>	240 GR/M <sup>2</sup>	240 GR/M <sup>2</sup>	240 GR/M <sup>2</sup>	240 GR/M <sup>2</sup>
	S	M	L	XL	2XL
	CE CAT-I	CE CAT-I	CE CAT-I	CE CAT-I	CE CAT-I
	8 424835 008581	8 424835 008598	8 424835 008604	8 424835 008611	8 424835 008628

## Pantalón

### Trouser

Calça

**Cuerpo de 65% poliéster y 35% algodón**

**Refuerzos de doble costura**

**Fondo blanco, con bolsillos y costuras en negro**

**Cierre con cremallera y botón - Cintura elástica**

**Transpirable**

**Incluye 6 bolsillos**

65% polyester and 35% cotton body

Double-stitched gussets

White background, with black pockets and stitchings

Zipper and button closing - Elastic waist

Breathable

Includes 6 pockets

Corpo de 65% poliéster e 35% algodão

Reforços de costura dupla

Fundo branco, com bolsos e costuras em preto

Fechamento com zíper e botão - Cintura elástica

Respirável

Inclui 6 bolsos



	<b>WK102870</b> 20 / 001-008.400	<b>WK102880</b> 20 / 001-008.400	<b>WK102890</b> 20 / 001-008.400	<b>WK102900</b> 20 / 001-008.400	<b>WK102910</b> 20 / 001-008.400
	240 GR/M <sup>2</sup>	240 GR/M <sup>2</sup>	240 GR/M <sup>2</sup>	240 GR/M <sup>2</sup>	240 GR/M <sup>2</sup>
	S	M	L	XL	2XL
	CE CAT-I	CE CAT-I	CE CAT-I	CE CAT-I	CE CAT-I
	8 424835 006839	8 424835 006846	8 424835 006853	8 424835 006860	8 424835 006877

## Pantalón-peto

### Bib-trouser

#### Calça-peto

**Cuerpo de 65% poliéster y 35% algodón**

**Refuerzos de doble costura**

**Fondo blanco, con bolsillos, hebillas y costuras en negro**

**Cierre con cremallera**

**Cintura elástica**

**Transpirable**

**Incluye 7 bolsillos**

65% polyester and 35% cotton body

Double-stitched gussets

White background, with black pockets, buckles and stitchings

Zipper closing

Elastic waist

Breathable

Includes 7 pockets

Corpo de 65% poliéster e 35% algodão

Reforços de costura dupla

Fundo branco, com bolsos, fivelas e costuras em preto

Fechamento com zíper

Cintura elástica

Respirável

Inclui 7 bolsos



	<b>WK102620</b> 20 / 001-014.200	<b>WK102630</b> 20 / 001-014.200	<b>WK102640</b> 20 / 001-014.200	<b>WK102650</b> 20 / 001-014.200	<b>WK102660</b> 20 / 001-014.200
	240 GR/M <sup>2</sup>	240 GR/M <sup>2</sup>	240 GR/M <sup>2</sup>	240 GR/M <sup>2</sup>	240 GR/M <sup>2</sup>
	S	M	L	XL	2XL
	CE CAT-I	CE CAT-I	CE CAT-I	CE CAT-I	CE CAT-I
	8 424835 008758	8 424835 008765	8 424835 008772	8 424835 008789	8 424835 008796

## Chaleco alta visibilidad

### High visibility vest

Colete alta visibilidade

**Cuerpo de poliéster**

**Cierre con velcro horizontal**

**Fondo amarillo fluorescente con ribete en negro**

**Transpirable**

Polyester body

Horizontal velcro closing

Yellow fluorescent background with black trim

Breathable

Corpo de poliéster

Fechamento com velcro horizontal

Fundo amarelo fluorescente com rebordo preto

Transpirável

EN 340  
EN ISO 20471

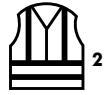

	<b>WK101270</b> 100 / 010-001.500	<b>WK101280</b> 100 / 010-001.500	<b>WK101290</b> 100 / 010-001.500
	120 GR/M <sup>2</sup>	120 GR/M <sup>2</sup>	120 GR/M <sup>2</sup>
	XS	M	XL
	CE CAT-II	CE CAT-II	CE CAT-II
	8 424835 006259	8 424835 006266	8 424835 006273

## Camiseta

### T-shirt

Camiseta

**Cuerpo de 65% poliéster y 35% algodón**  
**Refuerzos de doble costura**  
**Fondo blanco, con cuello y puños en negro**  
**Transpirable**

Polyester 65% and cotton 35% body  
 Double-stitched gussets  
 White background, with black collar and cuffs  
 Breathable

Corpo de 65% poliéster e 35% algodão  
 Reforços de costura dupla  
 Fundo branco com pescoço e punhos em preto  
 Transpirável



	<b>WK101410</b> 50 / 001-003.400	<b>WK101420</b> 50 / 001-003.400	<b>WK101430</b> 50 / 001-003.400	<b>WK101440</b> 50 / 001-003.400	<b>WK101450</b> 50 / 001-003.400
	180 GR/M <sup>2</sup>	180 GR/M <sup>2</sup>	180 GR/M <sup>2</sup>	180 GR/M <sup>2</sup>	180 GR/M <sup>2</sup>
	S	M	L	XL	2XL
	CE CAT-I	CE CAT-I	CE CAT-I	CE CAT-I	CE CAT-I
	8 424835 008666	8 424835 008673	8 424835 008680	8 424835 008697	8 424835 008703

## Polo

### Polo shirt

Pólo

**Cuerpo de 65% poliéster y 35% algodón**  
**Refuerzos de doble costura**  
**Fondo blanco, con cuello, cierre y puños en negro**  
**Cierre con 3 botones**  
**Transpirable**

Polyester 65% and cotton 35% body  
 Double-stitched gussets  
 White background, with black collar, closing and cuffs  
 Closing with 3 buttons  
 Breathable

Corpo de 65% poliéster e 35% algodão  
 Reforços de costura dupla  
 Fundo branco com pescoço e punhos em preto  
 Fechamento com 3 botões  
 Transpirável



	<b>WK102820</b> 50 / 001-003.800	<b>WK102830</b> 50 / 001-003.800	<b>WK102840</b> 50 / 001-003.800	<b>WK102850</b> 50 / 001-003.800	<b>WK102860</b> 50 / 001-003.800
	180 GR/M <sup>2</sup>	180 GR/M <sup>2</sup>	180 GR/M <sup>2</sup>	180 GR/M <sup>2</sup>	180 GR/M <sup>2</sup>
	S	M	L	XL	2XL
	CE CAT-I	CE CAT-I	CE CAT-I	CE CAT-I	CE CAT-I
	8 424835 005382	8 424835 005399	8 424835 005405	8 424835 005412	8 424835 005429



## Polo manga larga

### Long sleeve polo shirt

Polo manga comprida

**Cuerpo de 65% poliéster y 35% algodón**  
**Refuerzos de doble costura**  
**Fondo blanco, con cuello, cierre y puños en negro**  
**Cierre con 3 botones**  
**Transpirable**

Polyester 65% and cotton 35% body  
 Double-stitched gussets  
 White background, with black collar, closing and cuffs  
 Closing with 3 buttons  
 Breathable

Corpo de 65% poliéster e 35% algodão  
 Reforços de costura dupla  
 Fundo branco, com pescoço, fechamento e punhos em preto  
 Fechamento com 3 botões  
 Transpirável



	<b>WK101500</b> 50 / 001-004.800	<b>WK101510</b> 50 / 001-004.800	<b>WK101520</b> 50 / 001-004.800	<b>WK101530</b> 50 / 001-004.800	<b>WK101540</b> 50 / 001-004.800
	180 GR/M <sup>2</sup>	180 GR/M <sup>2</sup>	180 GR/M <sup>2</sup>	180 GR/M <sup>2</sup>	180 GR/M <sup>2</sup>
	S	M	L	XL	2XL
	CE CAT-I	CE CAT-I	CE CAT-I	CE CAT-I	CE CAT-I
	8 424835 008802	8 424835 008819	8 424835 008826	8 424835 008833	8 424835 008840

## Suéter

### Sweater

Suéter

**Cuerpo de 65% poliéster y 35% algodón**  
**Refuerzos de doble costura**  
**Fondo blanco, con cuello, cintura y puños en negro**  
**Cintura y puños elásticos**  
**Transpirable**

Polyester 65% and cotton 35% body  
 Double-stitched gussets  
 White background, with black collar, waist and cuffs  
 Elastic waist and cuffs  
 Breathable

Corpo de 65% poliéster e 35% algodão  
 Reforços de costura dupla  
 Fundo branco, com pescoço, cintura e punhos em preto  
 Cintura e punhos elásticos  
 Transpirável



	<b>WK101630</b> 25 / 001-009.400	<b>WK101640</b> 25 / 001-009.400	<b>WK101650</b> 25 / 001-009.400	<b>WK101660</b> 25 / 001-009.400	<b>WK101670</b> 25 / 001-009.400
	280 GR/M <sup>2</sup>	280 GR/M <sup>2</sup>	280 GR/M <sup>2</sup>	280 GR/M <sup>2</sup>	280 GR/M <sup>2</sup>
	S	M	L	XL	2XL
	CE CAT-I	CE CAT-I	CE CAT-I	CE CAT-I	CE CAT-I
	8 424835 008857	8 424835 008864	8 424835 008871	8 424835 008888	8 424835 008895

## Chaleco

### Vest

#### Colete

**Cuerpo de poliéster 150 Denier**

**Recubrimiento de PU**

**Refuerzos de doble costura**

**Fondo blanco, con cremalleras y forro interior en negro**

**Cierre con cremallera - Cintura elástica**

**Incluye 3 bolsillos**

Polyester 150 Denier body

PU coating

Double-stitched gussets

White background, with black zippers and inner lining

Zipper closing - Elastic waist

Includes 3 pockets

Corpo de poliéster 150 Denier

Recobrimento de PU

Reforços de costura dupla

Fundo branco com zíperes e forro interno em preto

Fechamento com zíper - Cintura elástica

Inclui 3 bolsos



	<b>WK102920</b> 20 / 001-009.500	<b>WK102930</b> 20 / 001-009.500	<b>WK102940</b> 20 / 001-009.500	<b>WK102950</b> 20 / 001-009.500	<b>WK102960</b> 20 / 001-009.500
	180+140 GR/M <sup>2</sup>	180+140 GR/M <sup>2</sup>	180+140 GR/M <sup>2</sup>	180+140 GR/M <sup>2</sup>	180+140 GR/M <sup>2</sup>
	S	M	L	XL	2XL
	CE CAT-I	CE CAT-I	CE CAT-I	CE CAT-I	CE CAT-I
	8 424835 006884	8 424835 006891	8 424835 006907	8 424835 006914	8 424835 006921

## Chaqueta softshell

### Softshell jacket

#### Jaqueta softshell

**Cuerpo de 96% poliéster y 4% spandex**

**Refuerzos de doble costura**

**Fondo blanco, con cremalleras y forro interior en negro**

**Cierre con cremallera - Cintura con ajuste de cordón**

**Puños con ajuste de velcro**

**Incluye 2 bolsillos**

Polyester 96% and spandex 4% body

Double-stitched gussets

White background, with black zippers and inner lining

Zipper closing - Cord adjustment waist

Velcro adjustment cuffs

Includes 2 pockets

Corpo de 96% poliéster e 4% spandex

Reforços de costura dupla

Fundo branco com zíperes e forro interno em preto

Fechamento com zíper - Cintura com ajuste de cordão

Punhos com ajuste de velcro

Inclui 2 bolsos



	<b>WK101310</b> 20 / 001-016.200	<b>WK101320</b> 20 / 001-016.200	<b>WK101330</b> 20 / 001-016.200	<b>WK101340</b> 20 / 001-016.200	<b>WK101350</b> 20 / 001-016.200
	280 GR/M <sup>2</sup>	280 GR/M <sup>2</sup>	280 GR/M <sup>2</sup>	280 GR/M <sup>2</sup>	280 GR/M <sup>2</sup>
	S	M	L	XL	2XL
	CE CAT-I	CE CAT-I	CE CAT-I	CE CAT-I	CE CAT-I
	8 424835 003548	8 424835 003616	8 424835 008635	8 424835 008642	8 424835 008659

## Guantes nitrilo

### Nitrile gloves

Luvas nitrile

**Cuerpo de poliéster**

**Recubrimiento de nitrilo en palma**

**Sin costuras**

**Fondo blanco, recubrimiento negro y puño en blanco-negro**

**Buena resistencia a la abrasión**

**Puño elástico**

Polyester body

Nitrile palm coating

Stitchless

White background, black coating and black-white cuff

Good abrasion resistance

Elastic cuff

Corpo de poliéster

Recobrimento de nitrilo em palma

Sem costuras

Fundo branco, recobrimento preto e punho em preto-branco

Boa resistência à abrasão

Punho elástico

EN 420

EN 388



4 1 2 1 X



	<b>WK101070</b> 120 / 012-000.600	<b>WK101080</b> 120 / 012-000.600	<b>WK100700</b> 120 / 012-000.600
	13	13	13
	M (8)	L (9)	XL (10)
	CE CAT-II	CE CAT-II	CE CAT-II
	8 424835 007133	8 424835 003647	8 424835 003760

## Guantes PU

### PU gloves

Luvras PU

**Cuerpo de poliéster**

**Recubrimiento de poliuretano en palma y dorso**

**Sin costuras**

**Fondo blanco, recubrimiento transparente y puño en blanco**

**Buena resistencia a la abrasión y al rasgado**

**Puño elástico**

Polyester body

Polyurethane palm and back coating

Stitchless

White background, transparent coating and white cuff

Good abrasion and tear resistance

Elastic cuff

Corpo de poliéster

Recobrimento de poliuretano em palma e dorso

Sem costuras

Fundo branco, recobrimento transparente e punho em branco

Boa resistência à abrasão e ao rasgado

Punho elástico



EN 420

EN 388



3 1 3 1 X

	<b>WK101060</b> 120 / 012-000.600	<b>WK101090</b> 120 / 012-000.600	<b>WK100710</b> 120 / 012-000.600
	13	13	13
	M (8)	L (9)	XL (10)
	CE CAT-II	CE CAT-II	CE CAT-II
	8 424835 007140	8 424835 600037	8 424835 003654

## Guantes PU

### PU gloves

Luvras PU

**Cuerpo de poliéster**

**Recubrimiento de poliuretano en palma y dorso**

**Sin costuras**

**Fondo negro, recubrimiento transparente y puño en negro**

**Buena resistencia a la abrasión y al rasgado**

**Puño elástico**

Polyester body

Polyurethane palm and back coating

Stitchless

Black background, transparent coating and black cuff

Good abrasion and tear resistance

Elastic cuff

Corpo de poliéster

Recobrimento de poliuretano em palma e dorso

Sem costuras

Fundo preto, recobrimento transparente e punho em preto

Boa resistência à abrasão e ao rasgado

Punho elástico



EN 420

EN 388



3 1 3 1 X

	<b>WK102700</b> 120 / 012-000.600	<b>WK100030</b> 120 / 012-000.600	<b>WK100040</b> 120 / 012-000.600
	13	13	13
	M (8)	L (9)	XL (10)
	CE CAT-II	CE CAT-II	CE CAT-II
	8 424835 007126	8 424835 003609	8 424835 003753

## Rodilleras inserción

### Insert kneepads





Joelheiras inserção

**Cuerpo de EVA y espuma**  
**Impermeable**

EVA and foam body  
Waterproof

Corpo de EVA e espuma  
Impermeável



	<b>WK100010</b> 40 / 001-002.900
	≤250 N
	75 GR
	CE CAT-I
	8 424835 003975

## Rodilleras

### Kneepads

Joelheiras

**Cuerpo de PVC y poliéster 600D**

**Relleno de espuma de gel y aire inyectado**

**Función antideslizante, antimarca y antirayadura**

**Impermeable**

PVC and 600D polyester body

Filled with gel foam and injected air

Anti-slip, anti-mark and anti-scratch function

Waterproof

Corpo de PVC e poliéster 600D

Recheado de espuma de gel e ar injetado

Função anti-deslizante, anti-marca e anti-riscadura







Impermeável



EN 14404  
EN ISO 13688



1

	<b>WK100290</b> 10 / 001-008.600
	≤250 N
	XL
	395 GR
	CE CAT-II
	8 424835 005764

## Rodilleras

### Kneepads

Joelheiras

**Cuerpo de PVC y poliéster 600D**

**Relleno de espuma de gel y aire inyectado**

**Función antideslizante, antimarca y antirayadura**  
**Impermeable**

PVC and 600D polyester body

Filled with gel foam and injected air

Anti-slip, anti-mark and anti-scratch function

Waterproof

Corpo de PVC e poliéster 600D

Recheado de espuma de gel e ar injetado

Função antii-deslizante, anti-marca e anti-riscadura







Impermeável



EN 14404  
EN ISO 13688



1

	<b>WK100300</b> 10 / 001-009.600
	≤250 N
	XL
	460 GR
	CE CAT-II
	8 424835 000332

## Rodilleras

### Kneepads

Joelheiras

**Cuerpo de PVC y poliéster 600D**

**Relleno de espuma de gel y aire inyectado**

**Función antideslizante, antimarca y antirayadura**  
**Impermeable**

PVC and 600D polyester body

Filled with gel foam and injected air

Anti-slip, anti-mark and anti-scratch function

Waterproof

Corpo de PVC e poliéster 600D

Recheado de espuma de gel e ar injetado

Função antii-deslizante, anti-marca e anti-riscadura







Impermeável



EN 14404  
EN ISO 13688



1

	<b>WK100340</b> 10 / 001-010.800
	≤250 N
	XL
	585 GR
	CE CAT-II
	8 424835 005757

## Traje impermeable

### Waterproof suit

Conjunto impermeável

**Cuerpo de poliéster 150T**  
**Recubrimiento de PVC**  
**Refuerzos de doble costura**  
**Fondo negro**  
**Cierre con cremallera**  
**Incluye 2 bolsillos y capucha**

150T polyester body  
 PVC coating  
 Double-stitched gussets  
 Black background  
 Zipper closing  
 Includes 2 pockets and hood

Corpo de poliéster 150T  
 Recobrimento de PVC  
 Reforços de costura dupla  
 Fundo preto  
 Fechamento com zíper  
 Inclui 2 bolsos e capuz



	<b>WK100350</b> 20 / 001-006.200	<b>WK100360</b> 20 / 001-006.200	<b>WK100370</b> 20 / 001-006.200	<b>WK100380</b> 20 / 001-006.200	<b>WK100390</b> 20 / 001-006.200
	0.16 MM	0.16 MM	0.16 MM	0.16 MM	0.16 MM
	S	M	L	XL	2XL
	CE CAT-I	CE CAT-I	CE CAT-I	CE CAT-I	CE CAT-I
	8 424835 006822	8 424835 006556	8 424835 006563	8 424835 006570	8 424835 006587

## Traje impermeable

### Waterproof suit

Conjunto impermeável

**Cuerpo de poliuretano - Recubrimiento de PVC**  
**Refuerzos de doble costura**  
**Fondo negro**  
**Solapa adicional con cierre de corchete**  
**Cierre con cremallera**  
**Incluye 2 bolsillos y capucha**

Polyurethane body - PVC coating  
 Double-stitched gussets  
 Black background  
 Additional flap with rivet button closing  
 Zipper closing  
 Includes 2 pockets and hood

Corpo de poliuretano - Recobrimento de PVC  
 Reforços de costura dupla  
 Fundo preto  
 Lapela adicional com fechamento de colchete  
 Fechamento com zíper  
 Inclui 2 bolsos e capuz



	<b>WK102720</b> 20 / 001-018.200	<b>WK102730</b> 20 / 001-018.200	<b>WK102740</b> 20 / 001-018.200	<b>WK102750</b> 20 / 001-018.200	<b>WK102760</b> 20 / 001-018.200
	0.40MM	0.40MM	0.40MM	0.40MM	0.40MM
	S	M	L	XL	2XL
	CE CAT-I	CE CAT-I	CE CAT-I	CE CAT-I	CE CAT-I
	8 424835 006990	8 424835 007003	8 424835 007010	8 424835 007027	8 424835 007034

**Casco**  
**Helmet**  
Capacete

- Cuerpo de HDPE**
- Estabilizador de rayos ultravioleta**
- Resistente a la perforación**
- Ajuste del arnés**
- Sistema de ventilación**

- HDPE body
- Ultraviolet rays stabilizer
- Penetration resistance
- Harness adjustment
- Ventilation system

- Corpo de HDPE
- Estabilizador de raios ultravioleta
- Resistente à perfuração
- Ajuste do arnés
- Sistema de ventilação



	<b>WK100180</b> ○ 20 / 001-005.600	<b>WK100400</b> ● 20 / 001-005.600	<b>WK100410</b> ● 20 / 001-005.600
	≤ 5 kN	≤ 5 kN	≤ 5 kN
	≥ 5 S	≥ 5 S	≥ 5 S
	-10-50° C	-10-50° C	-10-50° C
	54-63 CM	54-63 CM	54-63 CM
	CE CAT-II	CE CAT-II	CE CAT-II
	8 424835 006150	8 424835 001544	8 424835 001551



## Bolsa herramientas

### Tool bag

Saco ferramentas

**Cuerpo de poliéster 600D**  
**Fondo extra grueso de polietileno**  
**Refuerzos de doble costura**  
**Incluye 23 bolsillos**  
**Incluye correa de uso**

600D polyester body  
Extra thick polyethylene bottom  
Double-stitched gussets  
Includes 23 pockets  
Includes use belt

Corpo de poliéster 600D  
Fundo extra grosso de polietileno  
Reforços de costura dupla  
Inclui 23 bolsos  
Inclui correia de uso



○ I	<b>WK100720</b> 6 / 001-020.800
↕	500 MM
↔	250 MM
↕	315 MM
	8 424835 008710

## Bolsa herramientas abierta

### Open tool bag

Saco ferramentas aberto

**Cuerpo de poliéster 600D**  
**Fondo extra grueso de polietileno**  
**Asa metálica acolchada de caucho**  
**Refuerzos de doble costura**  
**Incluye 13 bolsillos y 18 sujeciones**  
**Incluye correa de uso**

600D polyester body  
Extra thick polyethylene bottom  
Rubber padded metallic handle  
Double-stitched gussets  
Includes 13 pockets and 18 fasteners  
Includes use belt

Corpo de poliéster 600D  
Fundo extra grosso de polietileno  
Alça metálica acolchoada de borracha  
Reforços de costura dupla  
Inclui 13 bolsos e 18 fixações  
Inclui correia de uso



○ I	<b>WK101000</b> 6 / 001-025.800
↕	500 MM
↔	250 MM
↕	350 MM
	8 424835 008734

## Bolsa-cubo herramientas abierta

### Open tool bag-bucket

Saco-balde ferramentas aberto

**Cuerpo de poliéster 600D**

**Fondo extra grueso de polietileno**

**Refuerzos de doble costura**

**Incluye 15 bolsillos y 30 sujeciones**

**Incluye correa de uso**

600D polyester body

Extra thick polyethylene bottom

Double-stitched gussets

Includes 15 pockets and 30 fasteners

Includes use belt

Corpo de poliéster 600D





Fundo extra grosso de polietileno

Reforços de costura dupla

Inclui 15 bolsos e 30 fixações

Inclui correia de uso



	<b>WK100740</b> 4 / 001-025.800
	260 MM
	300 MM
	8 424835 008727

## Gafas Glasses Óculos

EN 166

**Lentes de policarbonato**  
**Patillas de policarbonato**

Polycarbonate lenses  
Polycarbonate side-pieces

Lentes de policarbonato  
Hastes de policarbonato



## Gafas Glasses Óculos

EN 166

**Lentes de policarbonato**  
**Patillas de nylon**

Polycarbonate lenses  
Nylon side-pieces

Lentes de policarbonato  
Hastes de nylon



	<b>WK100820</b> 100 / 010-001.400
	F
	N
	1
	CE CAT-II
	8 424835 004187

	<b>WK101550</b> 100 / 010-001.400
	S
	N
	1
	CE CAT-II
	8 424835 004194

## Gafas Goggles Óculos

EN 166

**Lentes de policarbonato - Montura de PVC**  
**Banda elástica ajustable - Sistema de ventilación**

Polycarbonate lenses - PVC frame  
Elastic adjustable band - Ventilation system

Lentes de policarbonato - Armação de PVC  
Banda elástica ajustável - Sistema de ventilação



	<b>WK102710</b> 100 / 001-004.800
	F
	1
	CE CAT-II
	8 424835 000295

**Protector auditivo****Hearing protector**

Protetor auditivo

**Cuerpo de ABS****Banda de acero forjado y PVC****Flexible y extensible****Plegable****Ligero**

ABS body

Forged steel and PVC headband

Flexible and extensible

Foldable

Light

Corpo de ABS

Banda de aço forjado e PVC

Flexível e extensível

Dobrável

Leve

**WK101300**

20 / 001-005.200



25 dB



M



CE CAT-III



8 424835 005825

**Protector auditivo****Hearing protector**

Protetor auditivo

**Cuerpo de ABS****Banda de acero forjado y PVC****Flexible y extensible****Ligero**

ABS body

Forged steel and PVC headband

Flexible and extensible

Light

Corpo de ABS

Banda de aço forjado e PVC

Flexível e extensível

Leve

**WK101620**

20 / 001-007.400



29 dB



M



CE CAT-III



8 424835 005900

## Cinta amarre

### Cam buckle strap

Fita amarração

**Cuerpo de poliéster**

**Hebilla de zinc y aluminio**

**Agarre ergonómico**

**Coeficiente de seguridad de capacidad de carga de 2:1**

Polyester body

Zinc and aluminium buckle

Ergonomic grip

Load capacity safety coefficient of 2:1







Corpo de poliéster

Fivela de zinc e alumínio

Agarramento ergonômico

Coeficiente de segurança de capacidade de carga 2:1



	<b>WK100510</b>	<b>WK100520</b>
	96 / 001-002.200	36 / 001-004.900
	250 KG (daN)	500 KG (daN)
	3 M	4 M
	25 MM	35 MM
PCS	2	2
	TÜV GS	TÜV GS
	8 424835 003135	8 424835 002947

## Cinta trincaje Ratchet tie down

Fita amarração

Cuerpo de poliéster

Hebilla y gancho de acero inoxidable

Agarre ergonómico

Coefficiente de seguridad de capacidad de carga de 2:1

Polyester body

Stainless-steel buckle and hook

Ergonomic grip

Load capacity safety coefficient of 2:1

Corpo de poliéster

Fivela e gancho de aço inoxidável

Agarramento ergonômico

Coefficiente de segurança de capacidade de carga 2:1



	<b>WK100530</b>	<b>WK100540</b>	<b>WK100560</b>	<b>WK100570</b>	<b>WK100590</b>
	54 / 001-002.500	42 / 001-003.900	24 / 001-005.200	20 / 001-007.800	10 / 001-012.200
	500 KG (daN)	1000 KG (daN)	2000 KG (daN)	3000 KG (daN)	5000 KG (daN)
	250 KG (daN)	500 KG (daN)	1000 KG (daN)	1500 KG (daN)	2500 KG (daN)
	6 M	6 M	6 M	8 M	10 M
	25 MM	25 MM	35 MM	35 MM	50 MM
	TÜV GS	TÜV GS	TÜV GS	TÜV GS	TÜV GS
	8 424835 005139	8 424835 005832	8 424835 005894	8 424835 006600	8 424835 006594

# Lona

## Tarpaulin

Lona

**Cuerpo de polietileno**  
**Impermeable y reutilizable**  
**Esquinas reforzadas**  
**Fondo frontal blanco y dorsal negro**

Polyethylene body  
 Waterproof and re-usable  
 Reinforced corners  
 White front and black dorsal background

Corpo de polietileno  
 Impermeável e reutilizável  
 Esquinas reforçadas  
 Fundo frontal branco e dorsal preto



○ I	<b>WK100210</b> 20 / 001-003.200	<b>WK100220</b> 14 / 001-005.400	<b>WK100230</b> 8 / 001-009.600	<b>WK100240</b> 4 / 001-017.900	<b>WK100250</b> 2 / 001-034.600
↕	3 M	4 M	6 M	8 M	12 M
↔	2 M	3 M	4 M	6 M	8 M
∇ ∧	100 GR/M <sup>2</sup>	100 GR/M <sup>2</sup>	100 GR/M <sup>2</sup>	100 GR/M <sup>2</sup>	100 GR/M <sup>2</sup>
	8 424835 006204	8 424835 006211	8 424835 006228	8 424835 006235	8 424835 006242

## Cubretodo plástico

### Plastic drop sheet

Coertura plástica

**Cuerpo de polietileno**  
**Impermeable**

Polyethylene body  
Waterproof

Corpo de polietileno  
Impermeável



	<b>WK100830</b> 80 / 010-000.400	<b>WK100840</b> 50 / 010-000.600	<b>WK100860</b> 30 / 010-001.100	<b>WK100870</b> 20 / 010-001.600
	5 M	5 M	5 M	5M
	4 M	4 M	4 M	4 M
	7 $\mu\text{m}$	10 $\mu\text{m}$	20 $\mu\text{m}$	30 $\mu\text{m}$
	8 424835 007478	8 424835 007485	8 424835 007508	8 424835 007515

## Cubretodo plástico

### Plastic drop sheet

Coertura plástica

**Cuerpo de polietileno**  
**Impermeable**

Polyethylene body  
Waterproof

Corpo de polietileno  
Impermeável



	<b>WK100880</b> 16 / 006-002.400	<b>WK100890</b> 12 / 006-003.000
	50 M	50 M
	2 M	2 M
	7 $\mu\text{m}$	10 $\mu\text{m}$
	8 424835 007522	8 424835 007539



## Cinta repara grietas

### Crack repair tape

Fita repara fendas

**Cuerpo de fibra de vidrio**  
**Autoadhesiva**

Fiberglass body  
Self adhesive

Corpo de fibra de vidro  
Auto-adesiva



○ ┃	<b>WK100780</b> 50 / 010-000.900	<b>WK100790</b> 50 / 005-001.600
↕	20 M	20 M
↔	50 MM	100 MM
∨ ∧	0.3 MM	0.3 MM
▣	2 X 2 MM	2 X 2 MM
	8 424835 007843	8 424835 007850

## Cinta repara grietas

### Crack repair tape

Fita repara fendas

**Cuerpo de papel Kraft**  
**Autoadhesiva**

Kraft paper body  
Self adhesive

Corpo de papel Kraft  
Auto-adesiva



○ ┃	<b>WK100800</b> 50 / 010-000.500	<b>WK100810</b> 50 / 010-000.900
↕	10 M	20 M
↔	50 MM	50 MM
∨ ∧	0.12 MM	0.12 MM
	8 424835 007836	8 424835 007867

## Cinta seguridad

### Safety tape

Fita isolamento

**Cuerpo de polietileno**  
**Impresión en una cara**

Polyethylene body  
One side printed

Corpo de polietileno  
Impresão em uma face



○ ┃	<b>WK100470</b> 45 / 010-001.800	<b>WK100480</b> 36 / 006-002.400
↕	200 M	200 M
↔	50 MM	75 MM
∨ ∧	35 μm	35 μm
	8 424835 007331	8 424835 007348

## Cinta guardavivos

### Plasterboard corner tape

Fita canto placa gesso

**Cuerpo de papel Kraft**  
**Microperforado**  
**Aluminio flexible**

Kraft paper body  
 Microperforated  
 Flexible aluminium

Corpo de papel Kraft  
 Microperfurado  
 Alumínio flexível



	<b>WK101120</b> 10 / 001-006.400
	30 M
	50 MM
	0.26 / 0.60 MM
	CE
	8 424835 008208

## Filtro cubresuelo

### Floor cover

Filtro cobre-chão

**Cuerpo de poliéster y algodón**  
**Impermeable y reutilizable**  
**Absorbente de pinturas y líquidos**  
**Antideslizante**

Polyester and cotton body  
 Waterproof and re-usable  
 Paints and liquids absorbent  
 Anti-slip

Corpo de poliéster e algodão  
 Impermeável e reutilizável  
 Absorvente de pinturas e líquidos  
 Anti-deslizante



	<b>WK102980</b> 24 / 001-003.900	<b>WK102970</b> 10 / 001-007.200	<b>WK102670</b> 6 / 001-012.600
	5 M	10 M	20 M
	1 M	1 M	1 M
	200 GR/M <sup>2</sup>	200 GR/M <sup>2</sup>	200 GR/M <sup>2</sup>
	8 424835 006037	8 424835 003425	8 424835 002770



# Químicos técnicos

## Technical chemicals

Químicos técnicos



## Transformador óxido

### Rust transformer

Transformador óxido

**Actúa directamente contra el óxido**

**Fácil de usar, se aplica con brocha, rodillo, pistola o inmersión**

**Bajo costo, eficiencia excepcional de cobertura**

Acts directly against rust

Easy to use, to be applied by brush, roller, spray or immersion



Low cost, exceptional coverage efficiency

Age diretamente contra o óxido

Fácil de usar, é aplicado por pincel, rolo, spray ou imersão

Baixo custo, cobertura eficiência excepcional



	<b>WK200010</b> 24 / 024-003.000	<b>WK200020</b> 24 / 024-004.600	<b>WK200030</b> 12 / 012-007.600	<b>WK200040</b> 12 / 012-012.600
	125 ML	250 ML	500 ML	1000 ML
	8 424835 001254	8 424835 002503	8 424835 005009	8 424835 010003

## Transformador óxido

### Rust transformer

Transformador óxido

**Actúa directamente contra el óxido**

**Fácil de usar, se aplica con brocha, rodillo, pistola o inmersión**

**Bajo costo, eficiencia excepcional de cobertura**

Acts directly against rust

Easy to use, to be applied by brush, roller, spray or immersion



Low cost, exceptional coverage efficiency

Age diretamente contra o óxido

Fácil de usar, é aplicado por pincel, rolo, spray ou imersão

Baixo custo, cobertura eficiência excepcional



	<b>WK200060</b> 1 / 001-051.000	<b>WK200070</b> 1 / 001-212.000
	5 L	25 L
	8 424835 000011	8 424835 000028

## Expositor y surtido

### Display and assortment

Expositor e sortimento

Incluye 7x125 ml, 6x250 ml, 5x500 ml y 4x1000 ml  
Incluye 30 trípticos

Includes 7x125 ml, 6x250 ml, 5x500 ml and 4x1000 ml  
Includes 30 leaflets

Inclui 7x125 ml, 6x250 ml, 5x500 ml e 4x1000 ml  
Inclui 30 trípticos



○ I	<b>WK200230</b> 1 / 001-144.000
↑ ↓	325 MM
← →	390 MM
	8 424835 510008

## Expositor

### Display

Expositor

Incluye 30 trípticos

Includes 30 leaflets

Inclui 30 trípticos



○ I	<b>WK200080</b> 1 / 001-010.000
↑ ↓	325 MM
← →	390 MM
	8 424835 003845

## Surtido expositor

### Display assortment

Sortimento expositor

Incluye 7x125 ml, 6x250 ml, 5x500 ml y 4x1000 ml

Includes 7x125 ml, 6x250 ml, 5x500 ml and 4x1000 ml

Inclui 7x125 ml, 6x250 ml, 5x500 ml e 4x1000 ml



○ I	<b>WK200240</b> 1 / 001-142.000
	8 424835 001612

## Trípticos

### Leaflets

Trípticos





○ I	<b>WK200090</b> 1 / 001-002.500
PCS	30
	8 424835 003852

# Simbología

## Symbology

### Simbologia

	<b>Referencia</b> Item Referência		<b>Segmentos</b> Segments Segmentos		<b>Diámetro órbita</b> Orbit diameter Diâmetro órbita		<b>Certificación</b> Certification Certificação
	<b>Potencia motor</b> Motor power Potência motor		<b>Viscosidad máxima</b> Maximum viscosity Viscosidade máxima		<b>Posiciones órbita</b> Orbit positions Posições órbita		<b>Capas</b> Layers Camadas
	<b>Compresor necesario</b> Necessary compressor Compressor necessário		<b>Consumo aire</b> Air consumption Consumo ar		<b>Capacidad carga cinta</b> Tape load capacity Capacidade carga fita	PCS	<b>Unidades</b> Pieces Unidades
	<b>Airless necesario</b> Necessary airless Airless necessário		<b>Diámetro base</b> Base diameter Diâmetro base		<b>Precisión</b> Precision Precisão	UV	<b>Absorción ultravioleta</b> Ultraviolet absorption Absorção ultravioleta
	<b>Potencia batería</b> Battery power Potência bateria		<b>Diámetro disco</b> Disc diameter Diâmetro disco		<b>Posiciones par</b> Torque positions Posições binário		<b>Clase óptica</b> Optical class Classe ótica
	<b>Carga batería</b> Battery charge Carregamento bateria		<b>Diámetro cable</b> Cable diameter Diâmetro cabo		<b>Par máximo</b> Maximum torque Binário máximo	≡	<b>Protección impactos</b> Impact protection Proteção impactos
	<b>Velocidades</b> Speeds Velocidades		<b>Diámetro manguera</b> Hose diameter Diâmetro mangueira		<b>Taladrado madera</b> Wood drilling Perfuração madeira		<b>Protección anti-vaho</b> Anti-fog protection Proteção anti-bafo
	<b>Medidas hoja</b> Blade sizes Medidas lâmina		<b>Diámetro paso fluido</b> Nozzle diameter Diâmetro passagem fluido		<b>Corte madera</b> Wood cutting Corte madeira		<b>Resistencia llamas</b> Flame resistance Resistência chamas
	<b>Revoluciones</b> Speed rate Rotações		<b>Diámetro corte</b> Cutting diameter Diâmetro corte		<b>Taladrado metal</b> Metal drilling Perfuração metal		<b>Potencia presión</b> Pressure power Potência pressão
	<b>Velocidad</b> Speed Velocidade		<b>Diámetro cartucho</b> Cartridge diameter Diâmetro cartucho		<b>Corte metal</b> Metal cutting Corte metal		<b>Ratio presión</b> Pressure ratio Ratio pressão
	<b>Impactos</b> Impacts Impactos		<b>Tipo punta/taco</b> Bit/stud type Tipo ponta/taco		<b>Taladrado hormigón</b> Concrete drilling Perfuração betão		<b>Medidas base</b> Base sizes Medidas base
	<b>Graduación</b> Graduation Gradação		<b>Tipo boquilla</b> Tip type Tipo boquilha		<b>Filtro partículas</b> Particles filter Filtro partículas		<b>Medidas hoja</b> Sheet sizes Medidas folha
	<b>Compatibilidad accesorio</b> Accessory compatibility Compatibilidade acessório		<b>Diámetro soporte</b> Support diameter Diâmetro suporte		<b>Clase</b> Class Classe		<b>Capacidad tamaño panel</b> Panel size capacity Capacidade tamanho painel
	<b>Presión succión</b> Vacuum pressure Pressão sucção		<b>Medidas cabezal</b> Head sizes Medidas cabeçal		<b>Peso</b> Weight Peso		<b>Medidas escalón</b> Step measures Medidas degrau
	<b>Presión trabajo</b> Working pressure Pressão trabalho		<b>Tomas corriente</b> Power sockets Tomadas corrente		<b>Capacidad carga</b> Load capacity Capacidade carga		<b>Medidas plataforma</b> Platform sizes Medidas plataforma
	<b>Presión máxima</b> Maximum pressure Pressão máxima		<b>Sincronización</b> Synchronisation Sincronização		<b>Límite carga en U</b> Load limit in U Limite carga em U		<b>Medidas base</b> Base sizes Medidas base
	<b>Potencia máxima</b> Maximum power Potência máxima		<b>Tipo cable</b> Cable type Tipo cabo		<b>Límite carga en línea</b> Load limit in line Limite carga em linha		<b>Medidas hoja</b> Sheet sizes Medidas folha

	<b>Temperatura</b> Temperature Temperatura		<b>Medidas</b> Sizes Medidas		<b>Diámetro clavo</b> Nail diameter Diâmetro prego		<b>Medida eje</b> Axis measurement Medida eixo
	<b>Color temperatura</b> Temperature colour Cor temperatura		<b>Movimiento</b> Motion Movimento		<b>Largo clavo</b> Nail length Comprimento prego		<b>Rosca entrada y salida</b> Inlet and outlet thread Rosca entrada e saída
	<b>Temperatura trabajo</b> Working temperature Temperatura trabalho		<b>Capacidad mezclado</b> Mixing capacity Capacidade misturado		<b>Altura total</b> Total height Altura total		<b>Rosca entrada</b> Inlet thread Rosca entrada
	<b>Resistencia temperatura</b> Temperature resistance Resistência temperatura		<b>Grosor</b> Thickness Grossura		<b>Altura plegada</b> Folded height Altura pregada		<b>Rosca salida</b> Outlet thread Rosca saída
	<b>Ángulo haz</b> Beam angle Ângulo feixe		<b>Capacidad corte</b> Cutting capacity Capacidade corte		<b>Altura A</b> A height Altura A		<b>Atornillado</b> Screw Aparafusado
	<b>Alcance haz</b> Beam reach Escopo feixe		<b>Profundidad atornillado</b> Screw depth Profundidade aparafusado		<b>Altura andamio</b> Scaffold height Altura andaime		<b>Capacidad</b> Capacity Capacidade
	<b>Caudal trabajo</b> Working flow Caudal trabalho		<b>Punzado metal</b> Metal punching Punçado metal		<b>Escalones</b> Steps Degraus		<b>Protección máxima</b> Maximum protection Proteção máxima
	<b>Caudal máximo</b> Maximum flow Caudal máximo		<b>Ancho corte</b> Cutting width Largura corte		<b>Distancia escalones</b> Step distance Distância degraus		<b>Resistencia perforación</b> Perforation resistance Resistência perforação
	<b>Ancho total</b> Total width Largura total		<b>Diámetro grapa 1</b> Staple 1 diameter Diâmetro agrafó 1		<b>Número dientes</b> Teeth number Número dentes		<b>Caudal aire</b> Air flow Caudal ar
	<b>Ancho hoja</b> Blade width Largura lâmina		<b>Ancho grapa 1</b> Staple 1 width Largura agrafó 1		<b>Grano</b> Grain Grão		<b>Portabrocas</b> Chuck Bucha
	<b>Largo total</b> Total length Comprimento total		<b>Largo grapa 1</b> Staple 1 length Comprimento agrafó 1		<b>Púas</b> Spikes Puas		<b>Energía impacto</b> Impact energy Energía impacto
	<b>Largo hoja</b> Blade length Comprimento lâmina		<b>Diámetro grapa 2</b> Staple 2 diameter Diâmetro agrafó 2		<b>Agujas</b> Needles Aglhas		<b>Talla</b> Size Tamanho
	<b>Largo cable</b> Cable length Comprimento cabo		<b>Ancho grapa 2</b> Staple 2 width Largura agrafó 2		<b>Malla</b> Mesh Malha		<b>Lumens</b> Lumens Lumens
	<b>Largo cartucho</b> Cartridge length Comprimento cartucho		<b>Largo grapa 2</b> Staple 2 length Comprimento agrafó 2		<b>Galga</b> Gauge Galga		<b>Duración LED</b> LED life Duração LED
	<b>Altura elevación</b> Lifting height Altura elevação		<b>Diámetro grapa 3</b> Staple 3 diameter Diâmetro agrafó 3		<b>Láminas</b> Sheets Lâminas		<b>Atenuación media</b> Mean attenuation Atenuação média
	<b>Altura total</b> Total height Altura total		<b>Ancho grapa 3</b> Staple 3 width Largura agrafó 3		<b>Código barras</b> Barcode Código barras		
	<b>Largo cerda</b> Bristle length Comprimento cerda		<b>Largo grapa 3</b> Staple 3 length Comprimento agrafó 3		<b>Tecnología LED</b> LED technology Tecnologia LED		



**Observaciones**  
**Remarks**  
Observações

**Se reserva el derecho a realizar correcciones  
y/o modificaciones sin notificación previa**

**Diseñado e impreso en España**

**Copyright 2022**

**Werku Tools SA**

**Reserved the right to make corrections  
and/or modifications without prior notice**

**Designed and printed in Spain**

**Copyright 2022**

**Werku Tools SA**

Se reserva o direito a realizar correções  
e/ou modificações sem notificação prévia

Desenhado e impresso em Espanha

Copyright 2022

Werku Tools SA



Werku Tools SA  
Carretera N-VI km 586  
E-15176 Oleiros - La Coruña  
Spain

T +34 981 648 119  
[info@werku.com](mailto:info@werku.com)  
[www.werku.com](http://www.werku.com)